

brick labs



6+

AB-1204

572  
ДЕТАЛИ

ОНЕКС-ТОРБУНОК

КОНСТРУКТОР СЕРИИ «СКАЗКИ»

ПО СКАЗКЕ П.П. ЕРШОВА

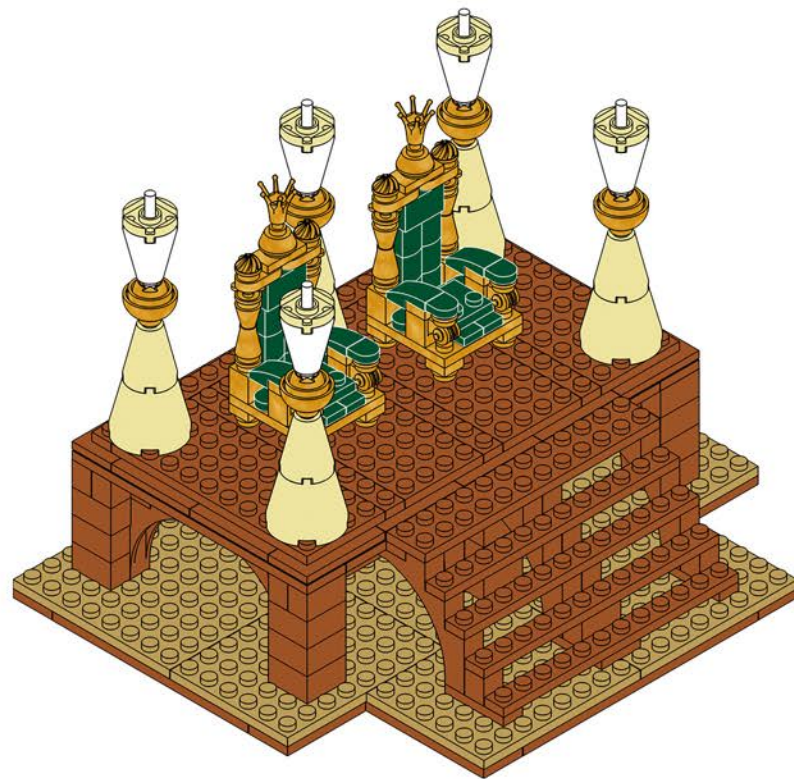



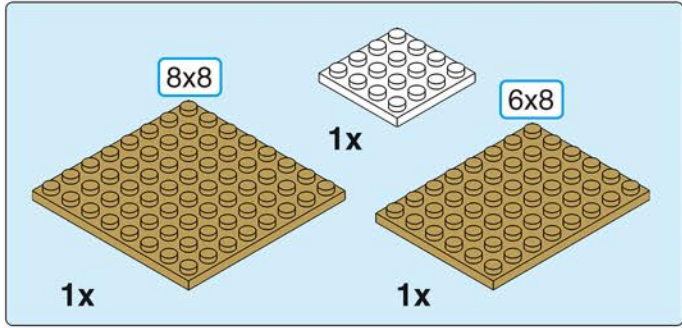

1-1

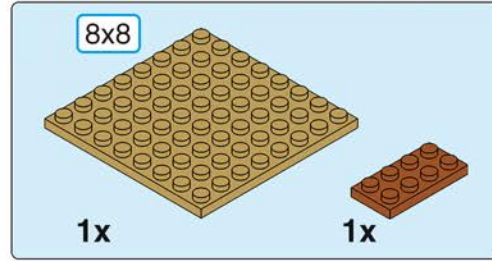
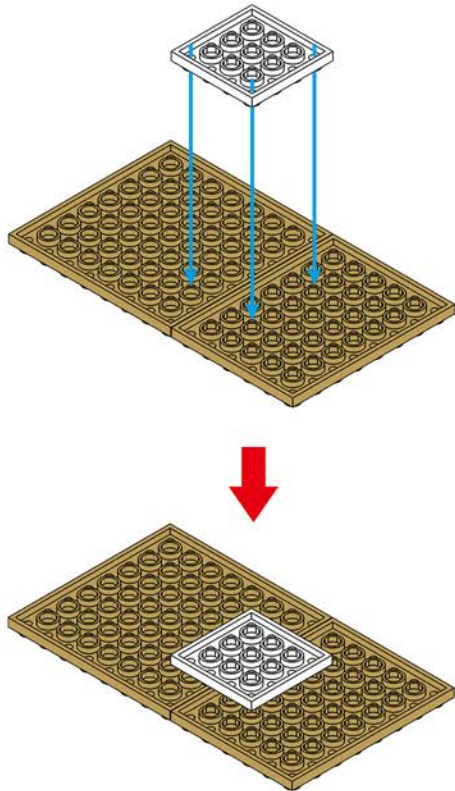

1-2

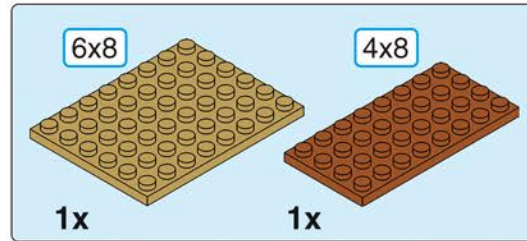
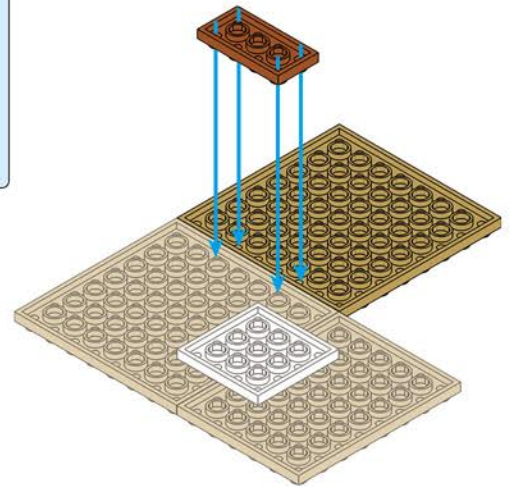

1-3

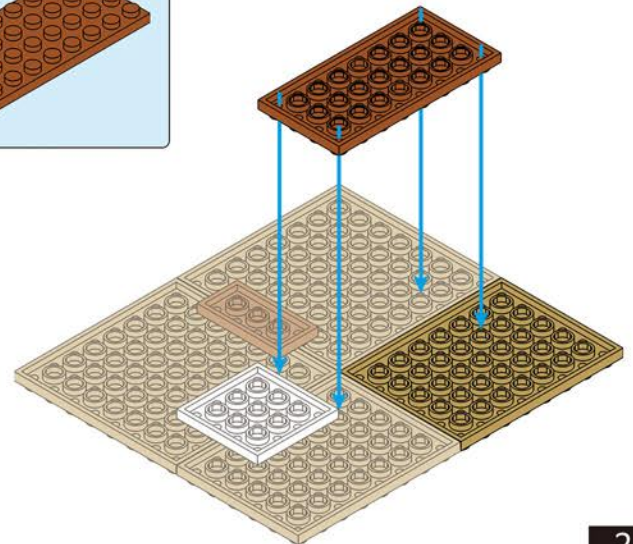

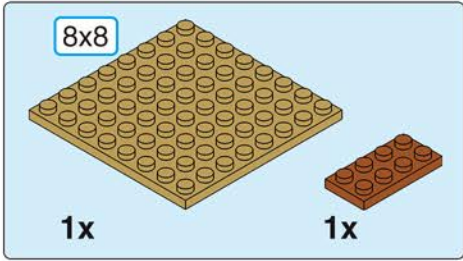

1-4

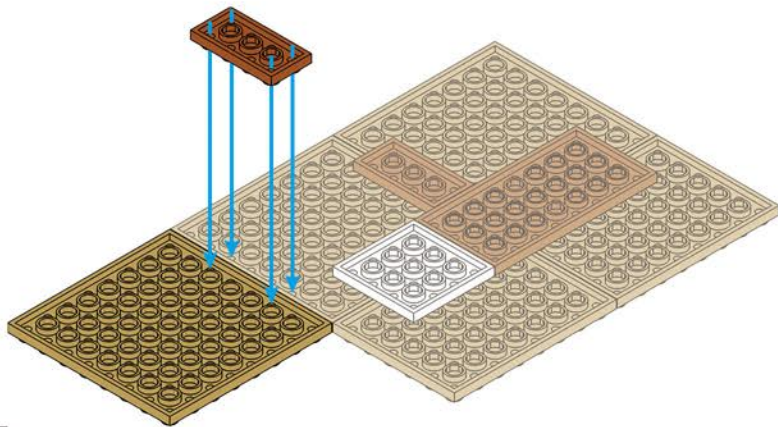

3

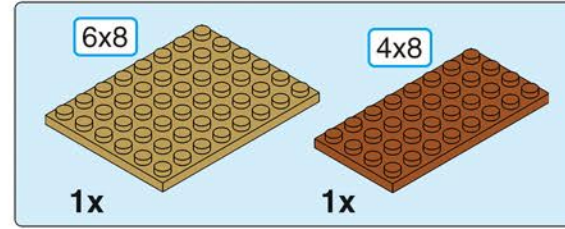

1-5

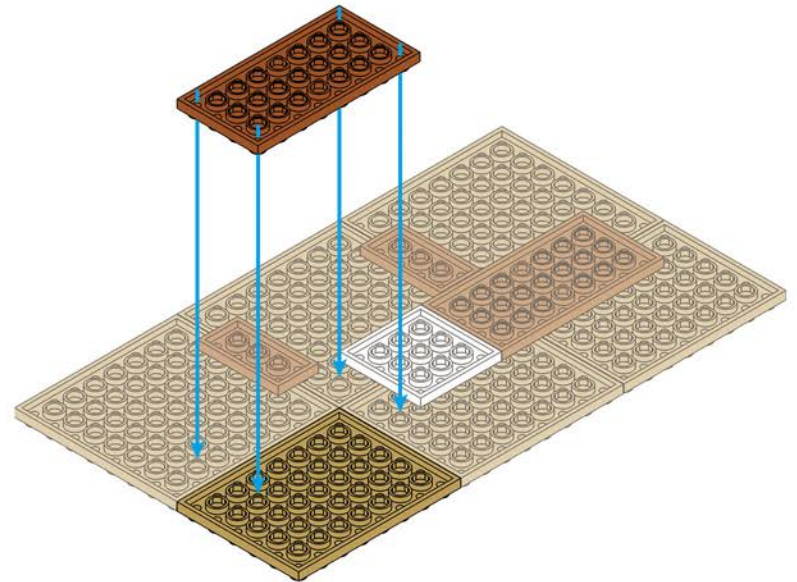

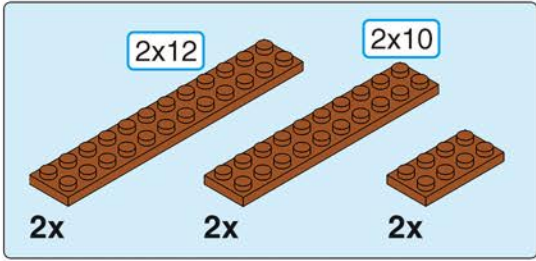

1-6

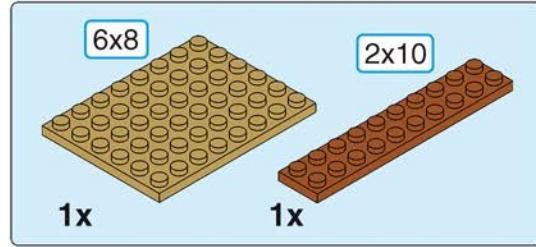

1-7

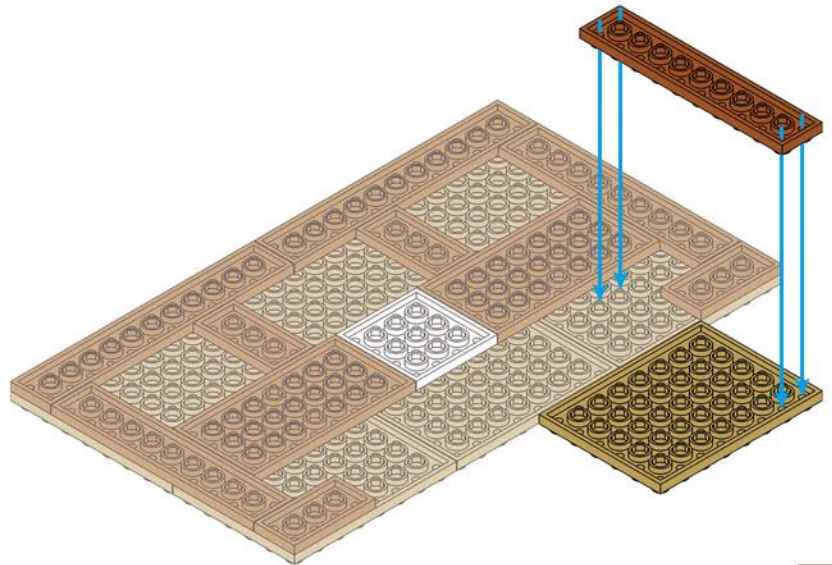



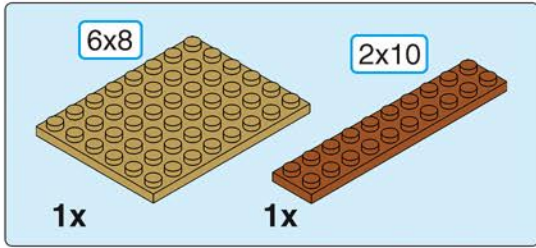

1-8

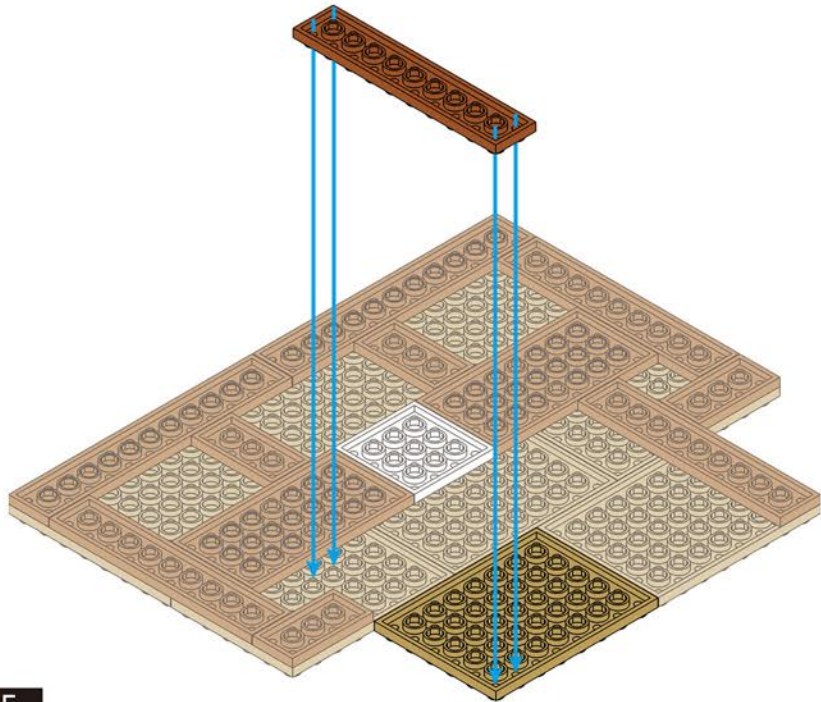

5

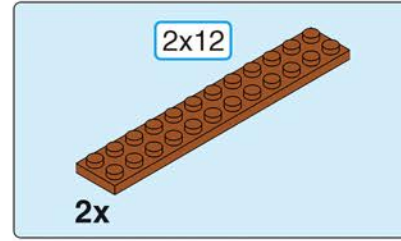

1-9

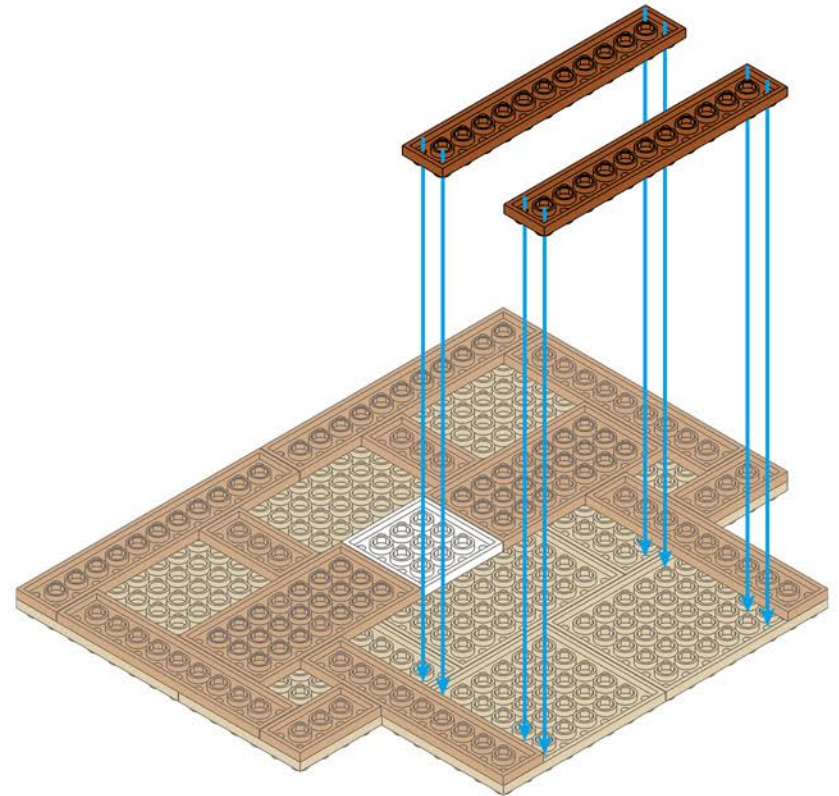

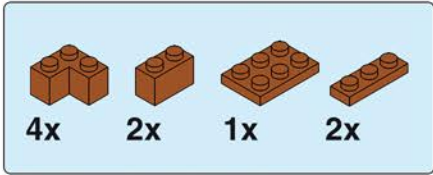

1-10

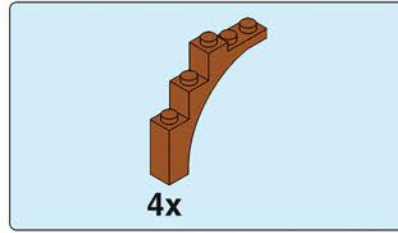
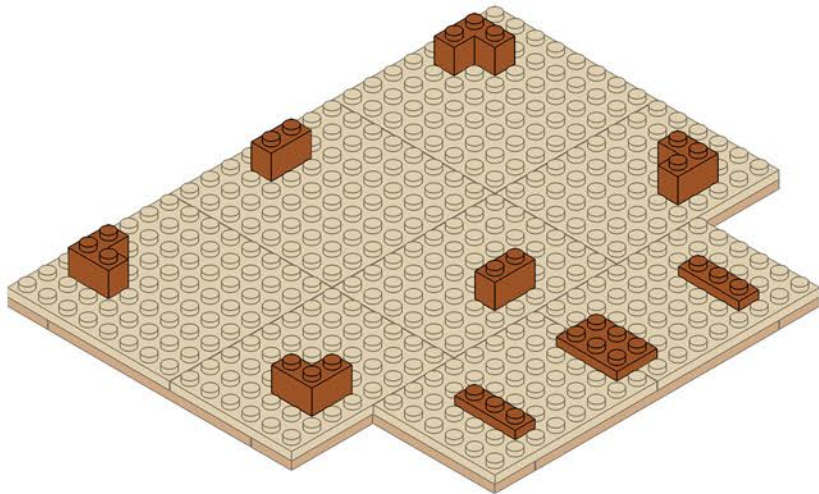

1-11

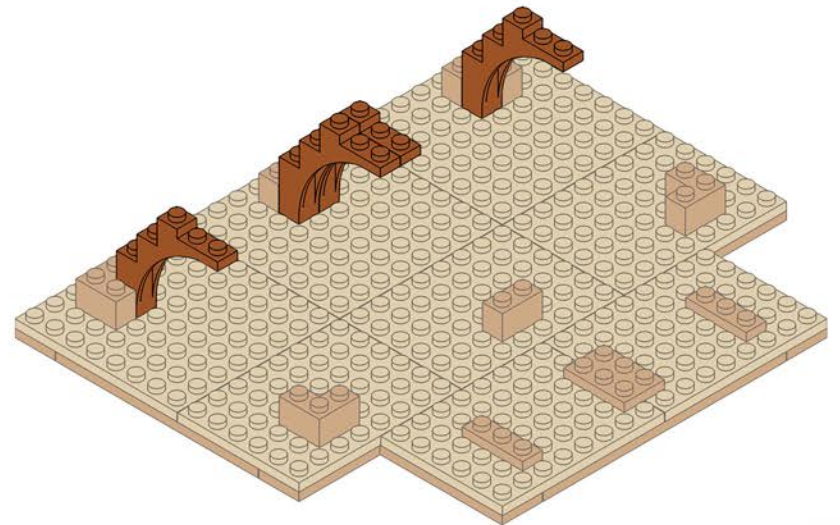

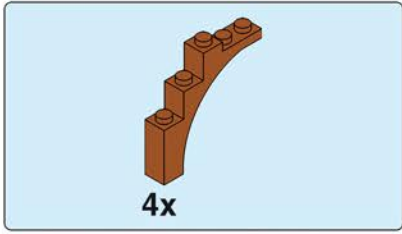

1-12

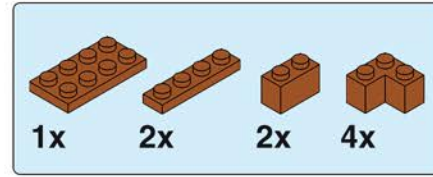
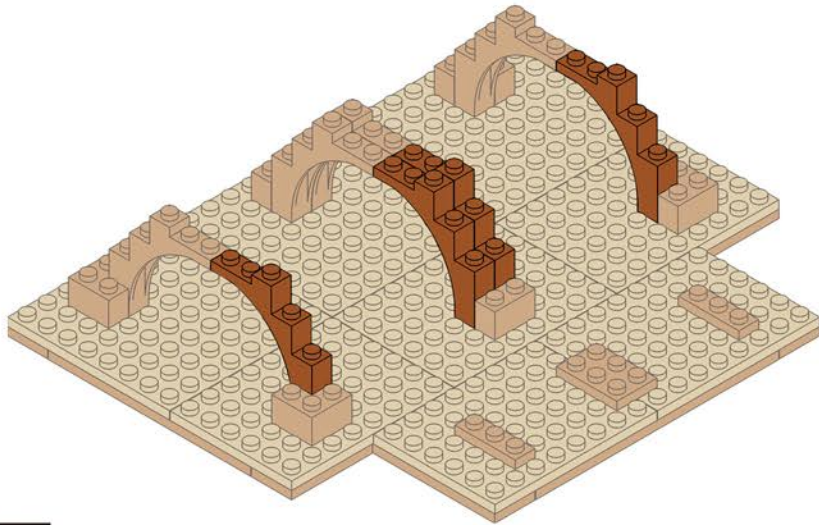

1-13

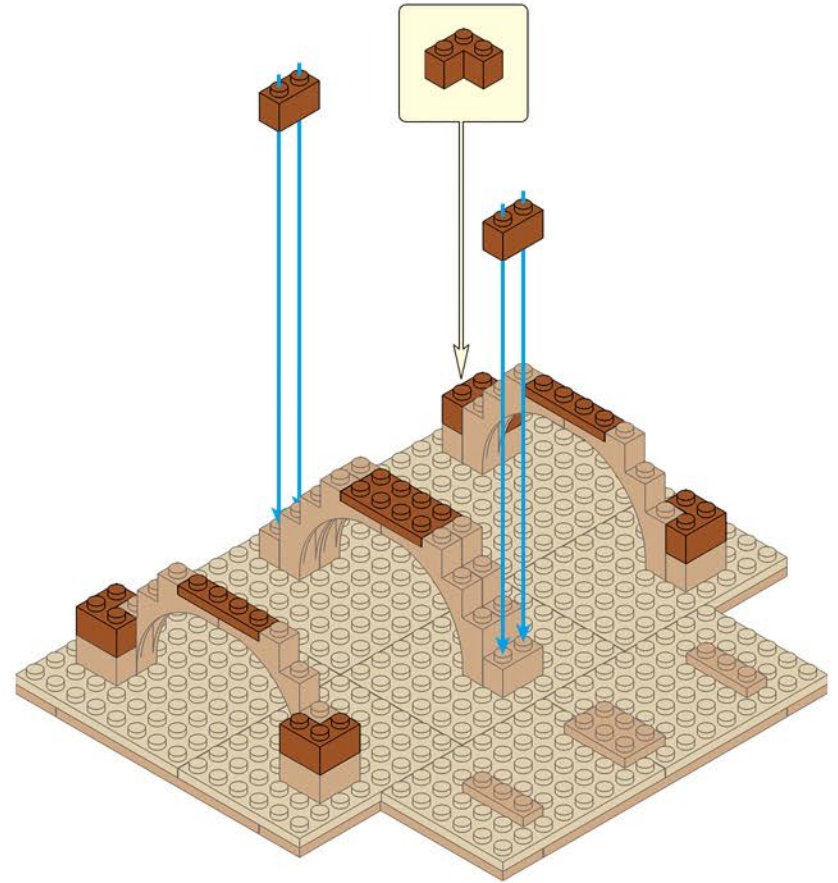



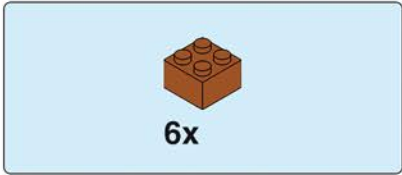

1-14

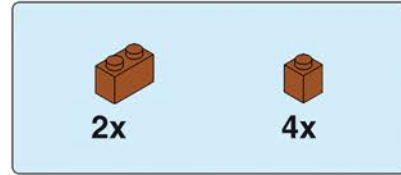
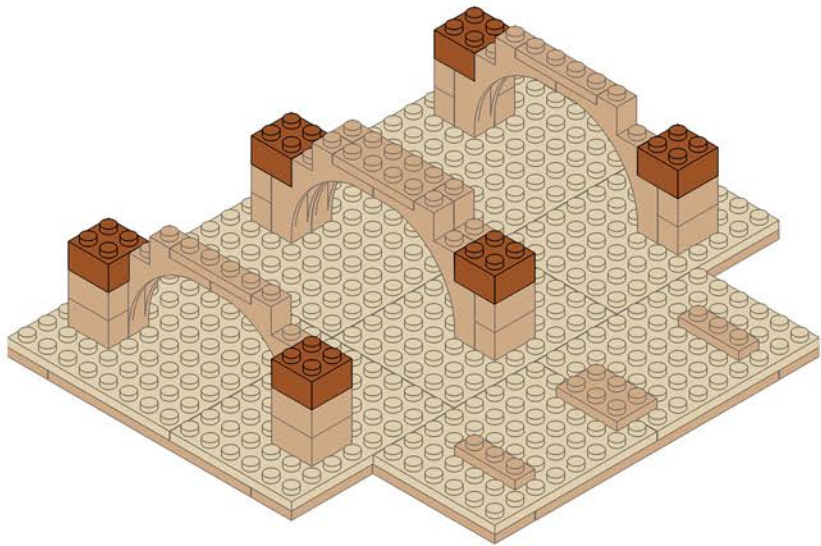

1-15

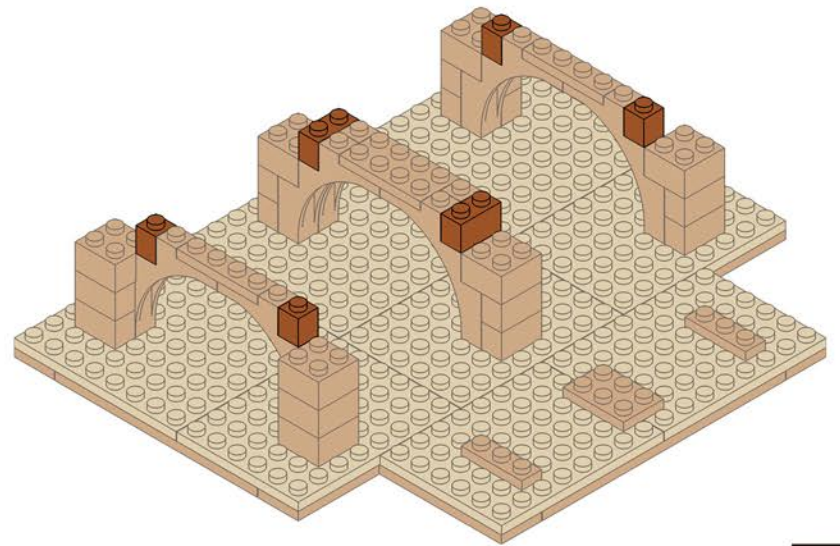

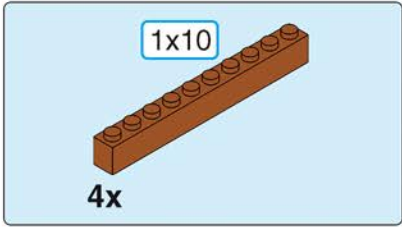

1-16

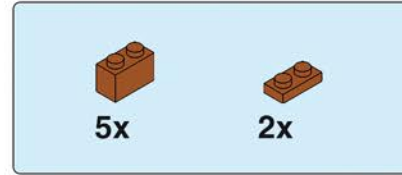
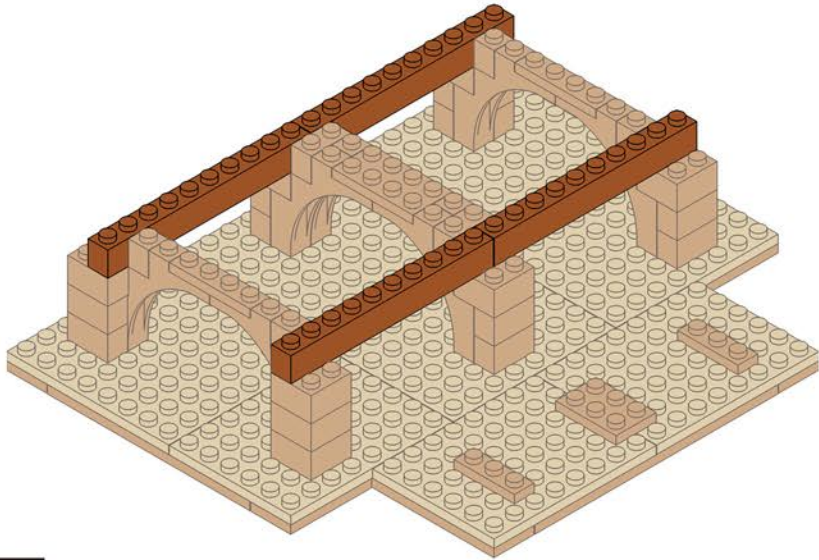

1-17

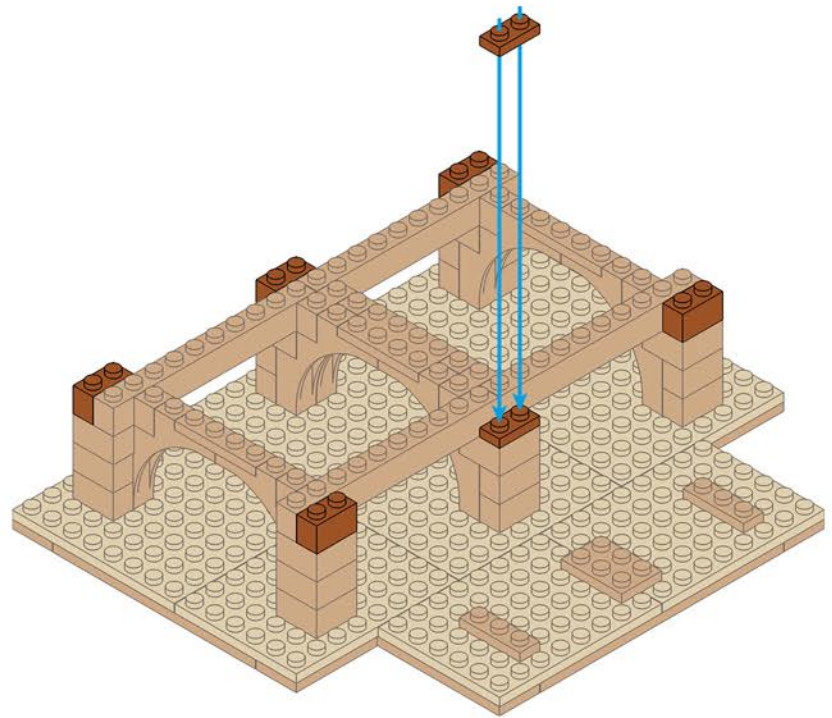

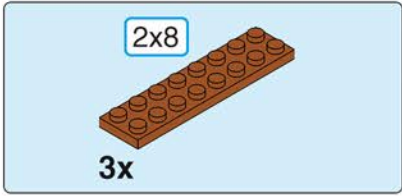

1-18

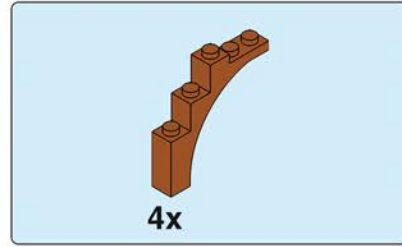
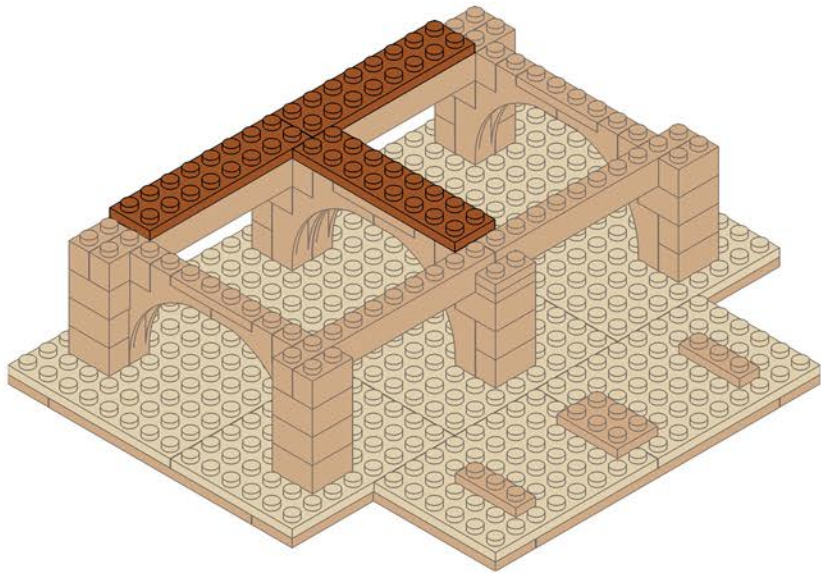

1-19

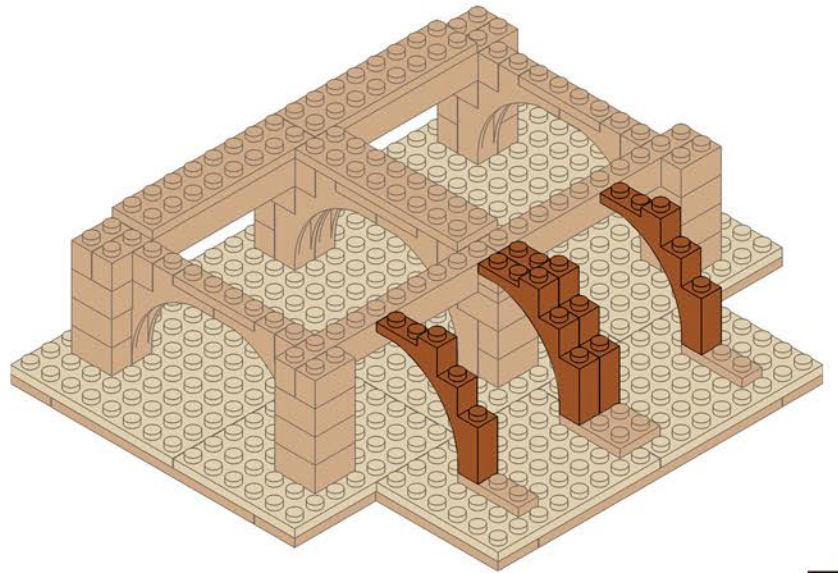



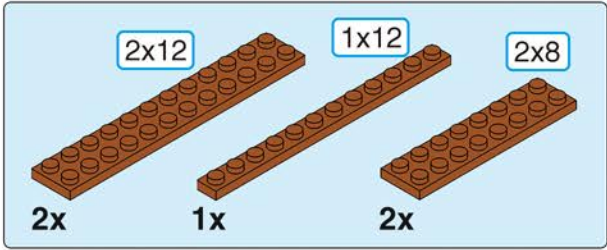

1-20

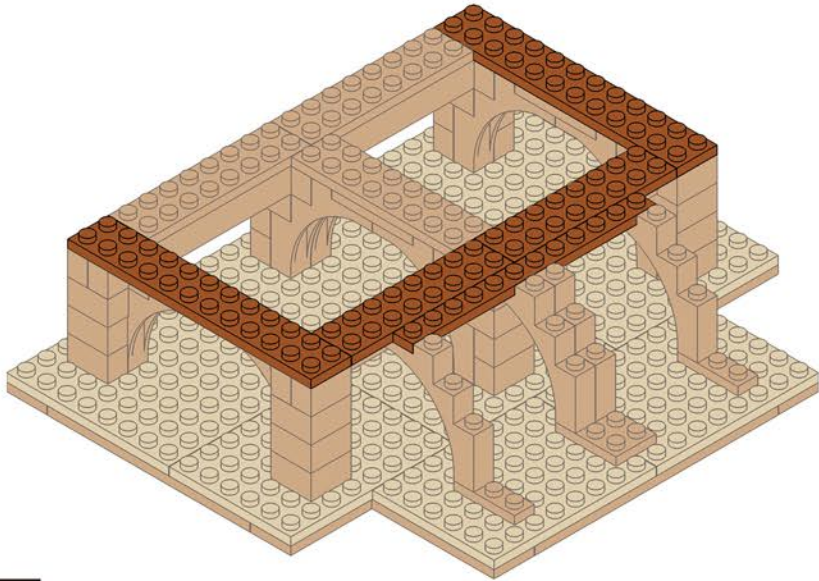

11

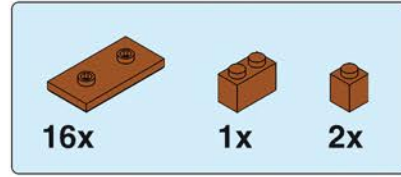

1-21

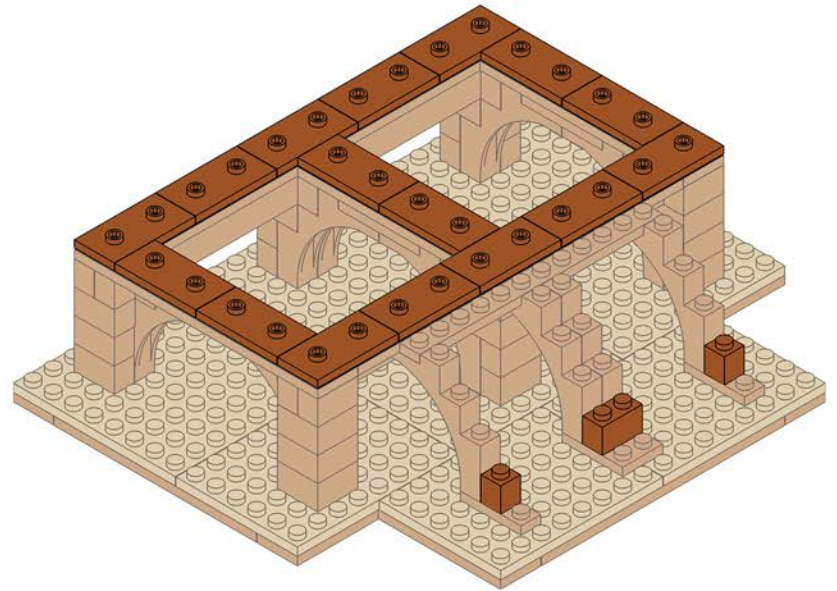

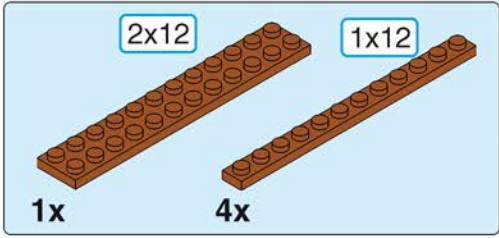

1-22

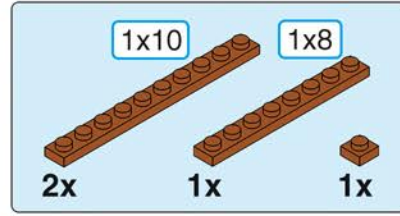
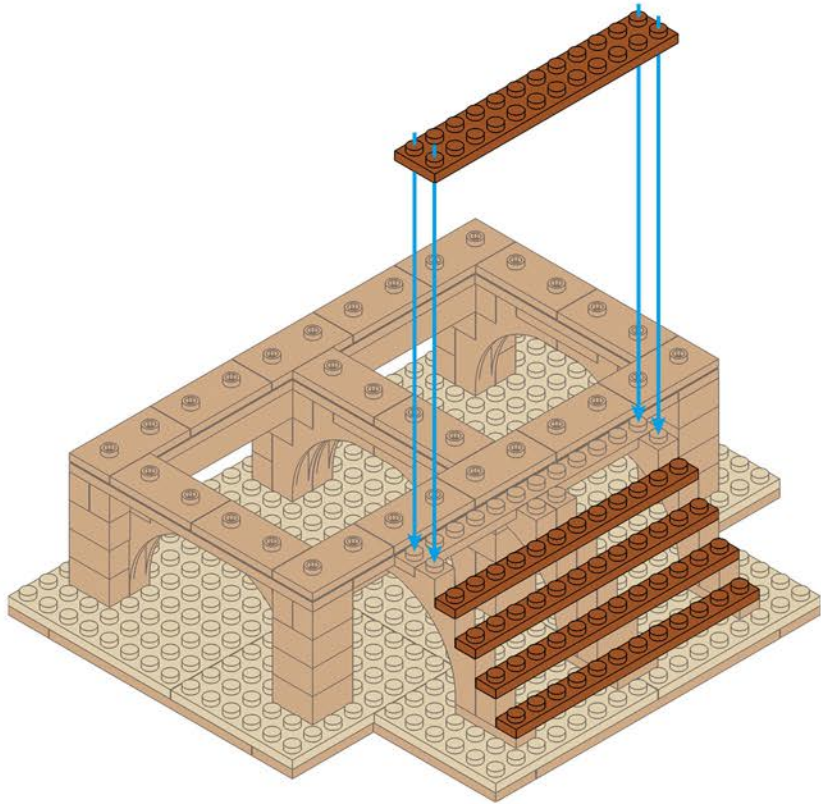

1-23

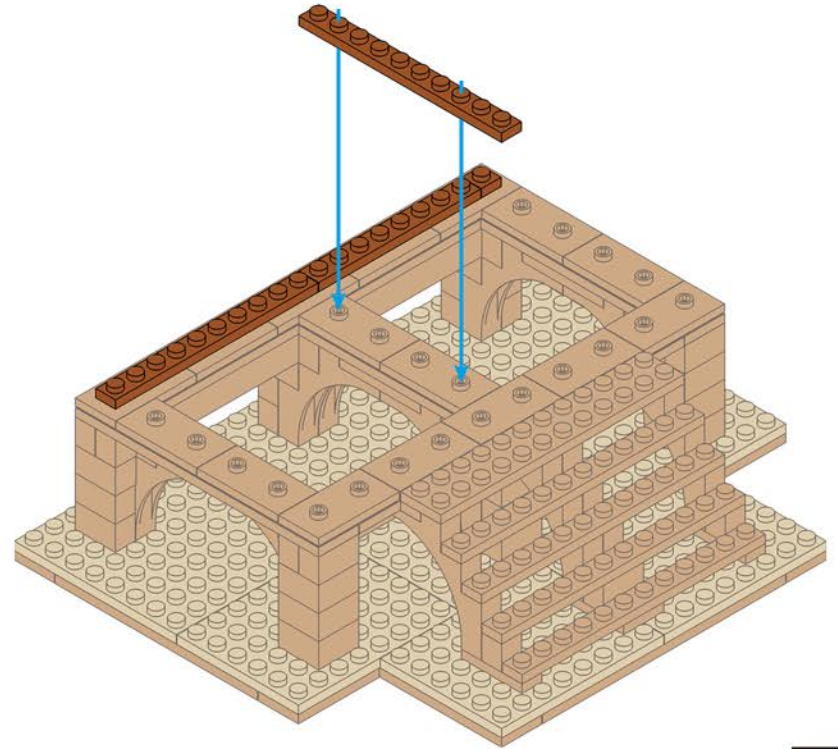



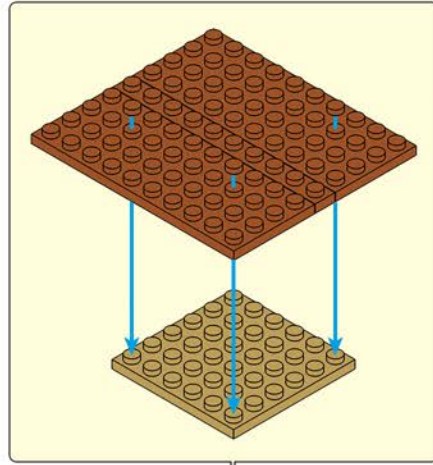
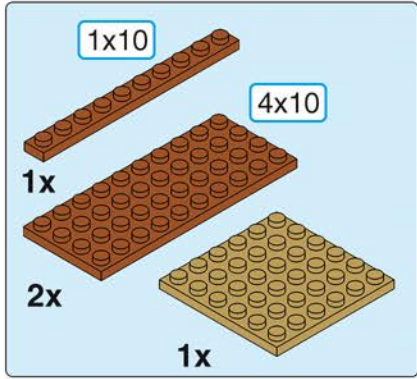

1-24

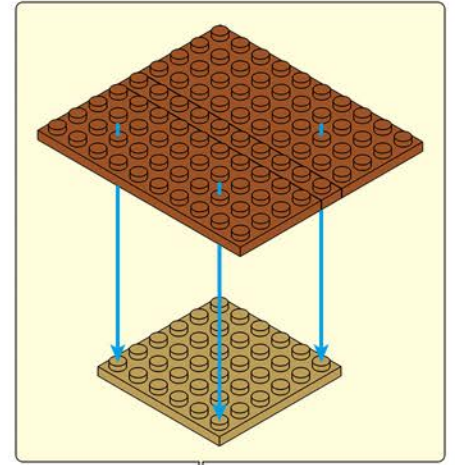
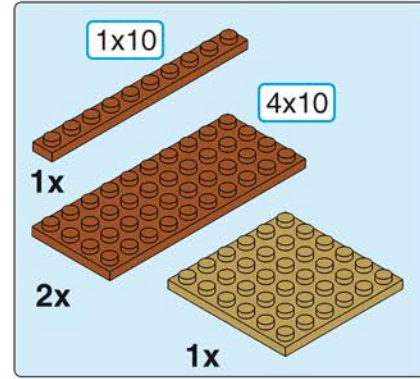
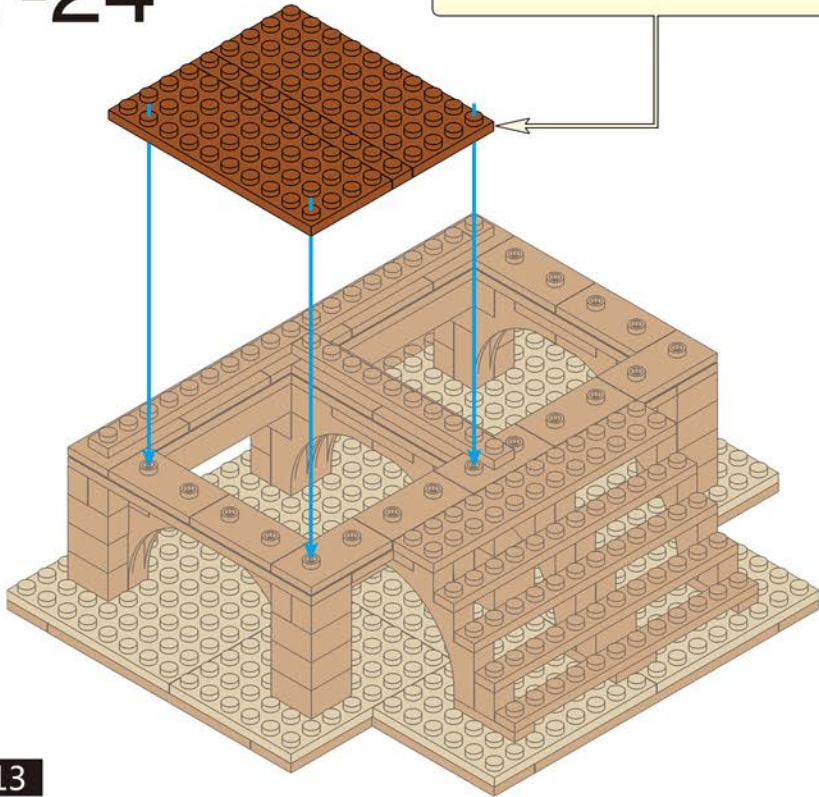

1-25

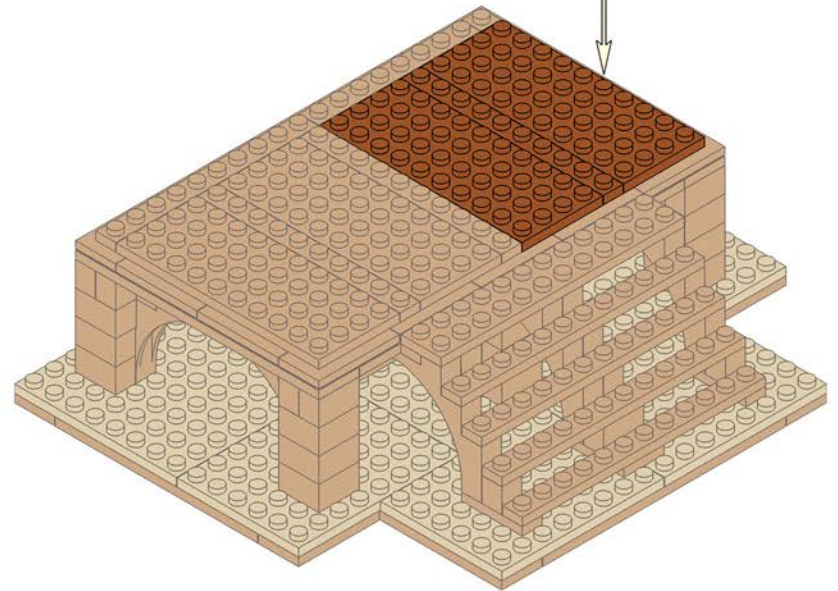



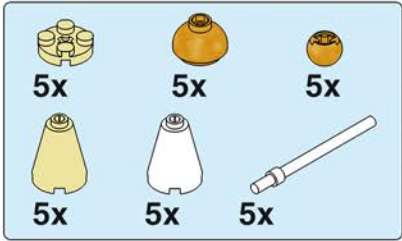

# 1-26

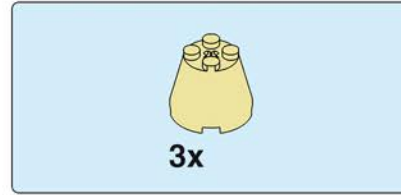
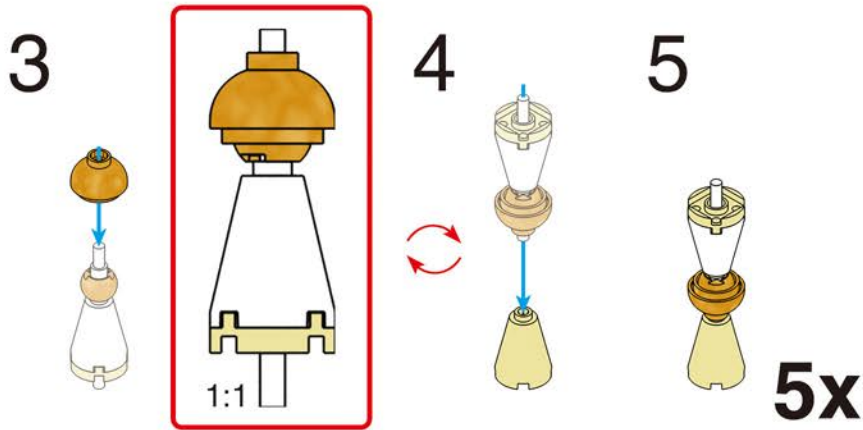
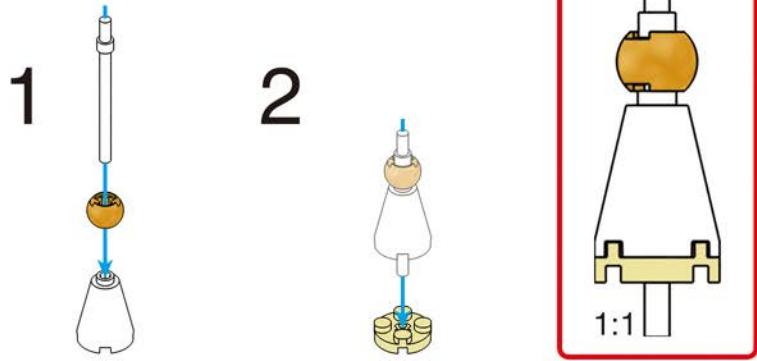

# 1-27

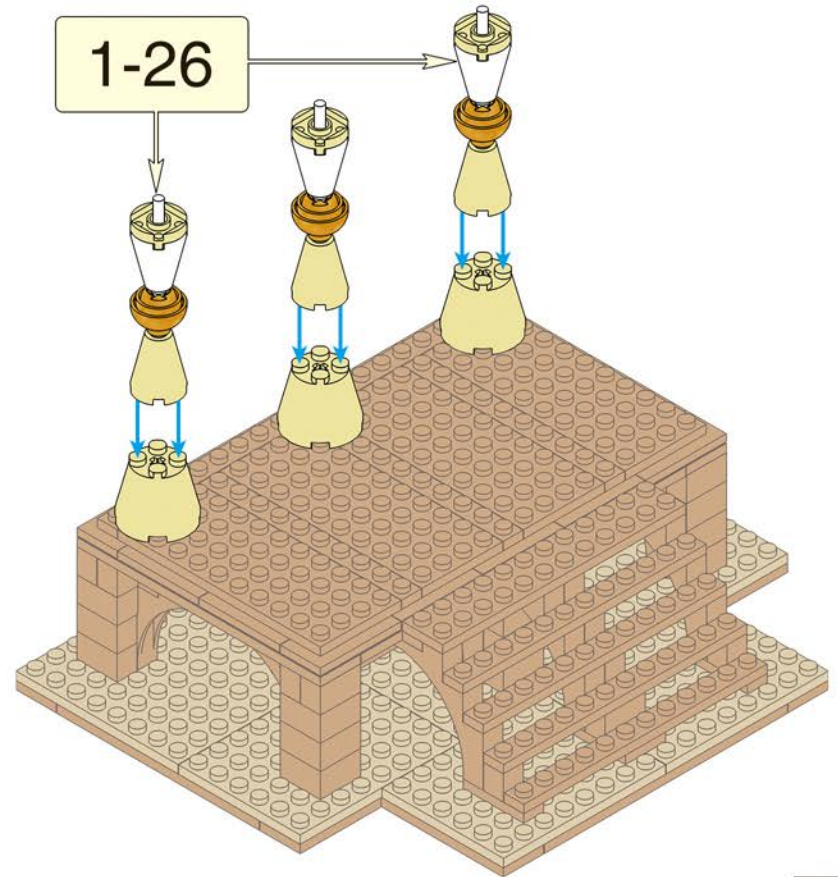

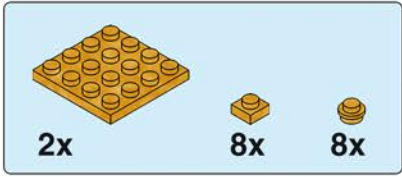

1-28

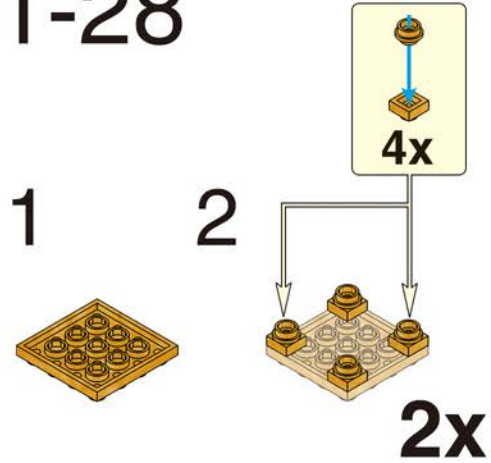

2x



1-29

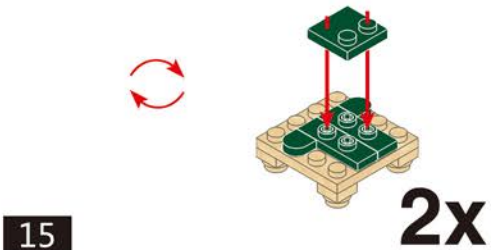

2x



1-30

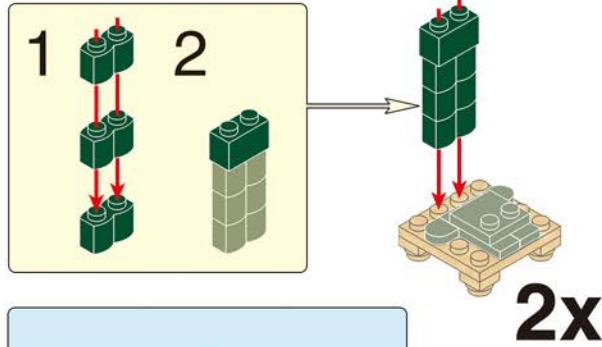

2x

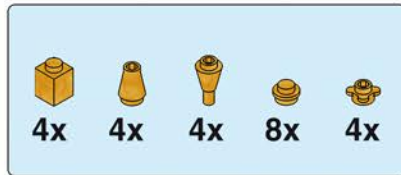

1-31

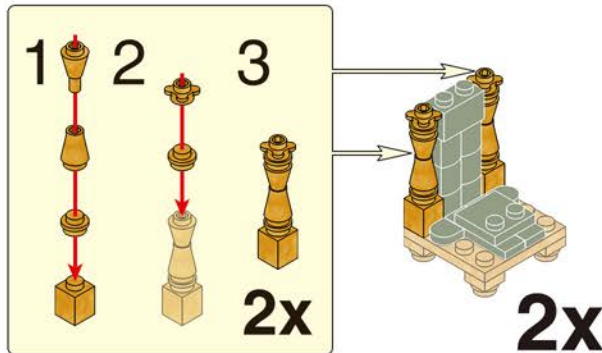

2x

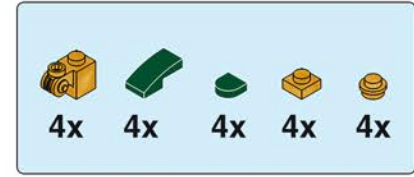

1-32

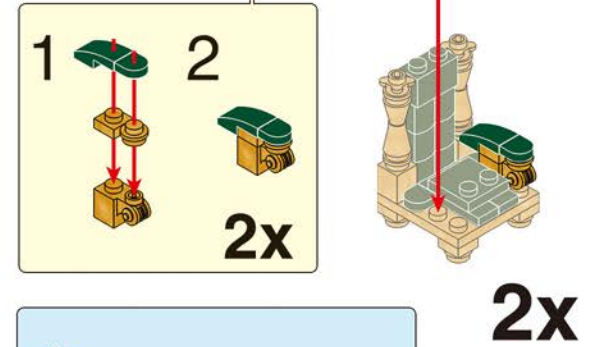

2x



1-33

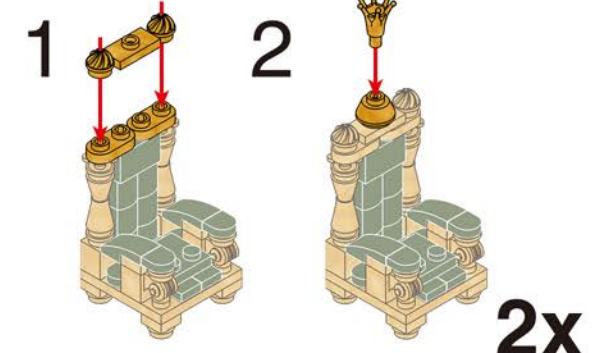

2x

# 1-34

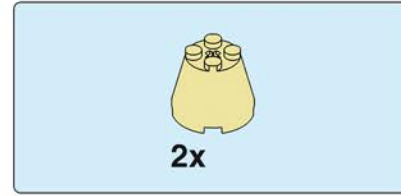
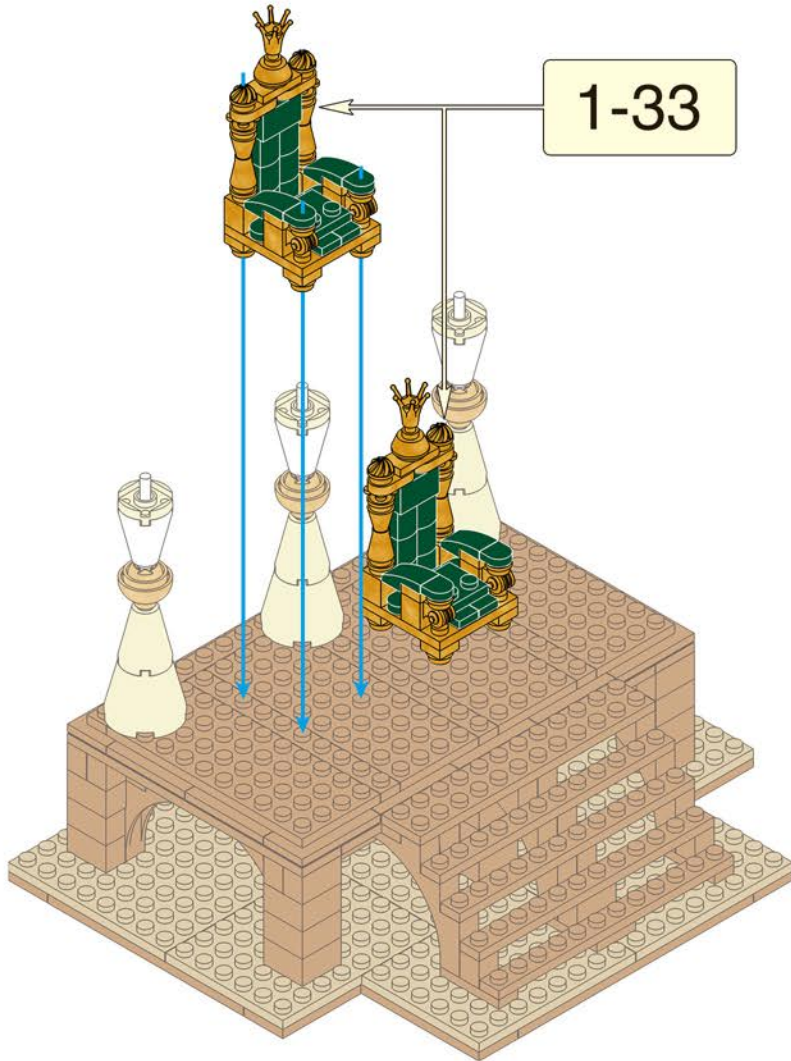

# 1-35

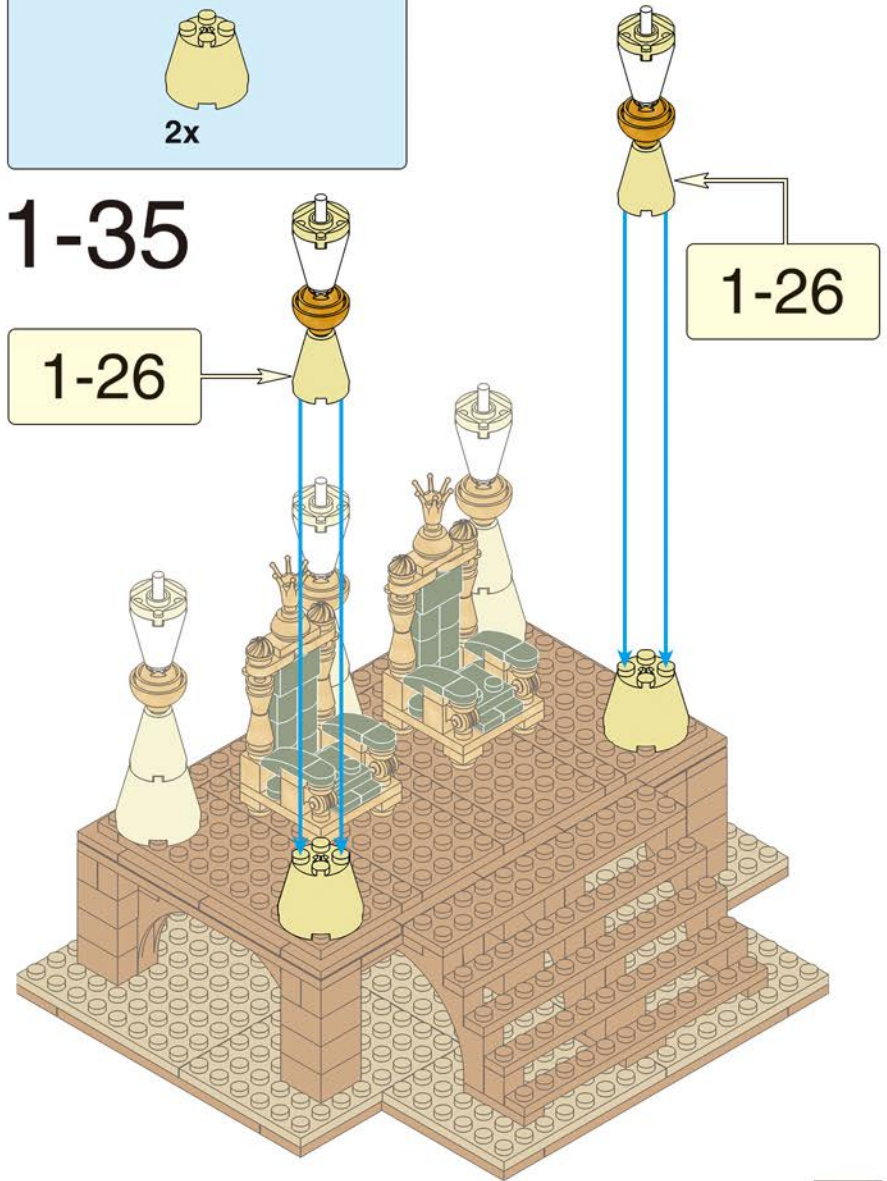
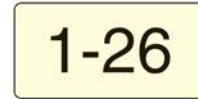



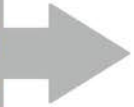

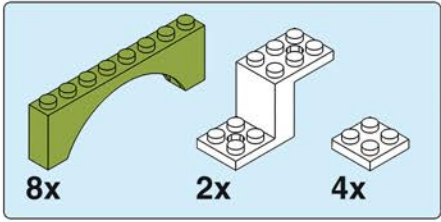

2-1

1

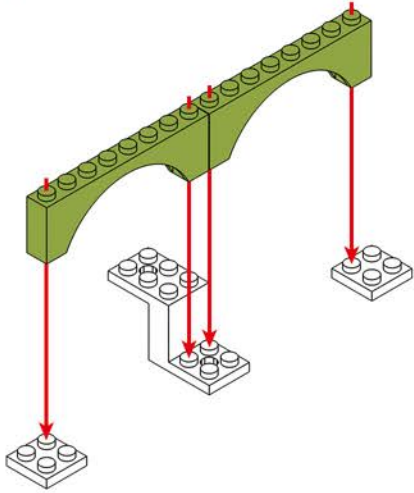

2

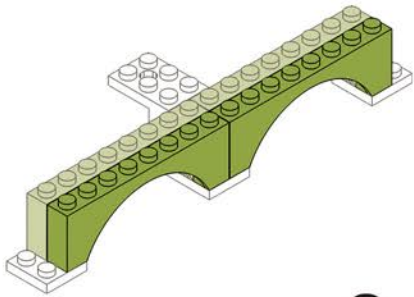

2x



2-2



A

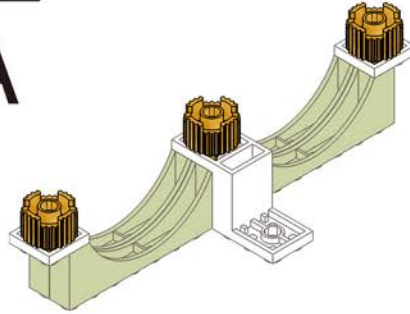

B

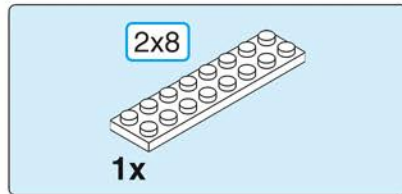
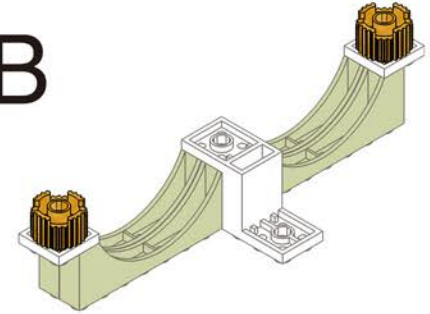

2-3

2-2A

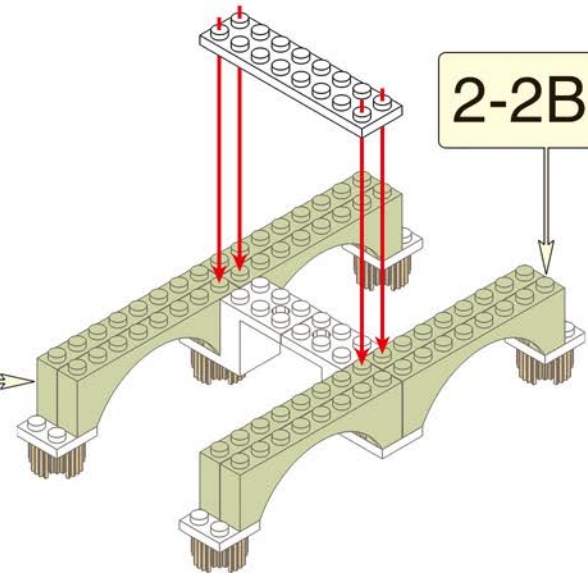

2-2B



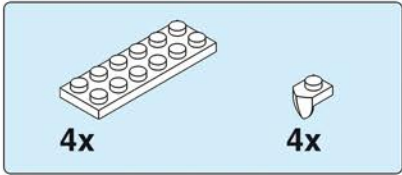

2-4

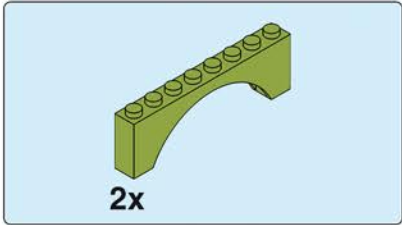
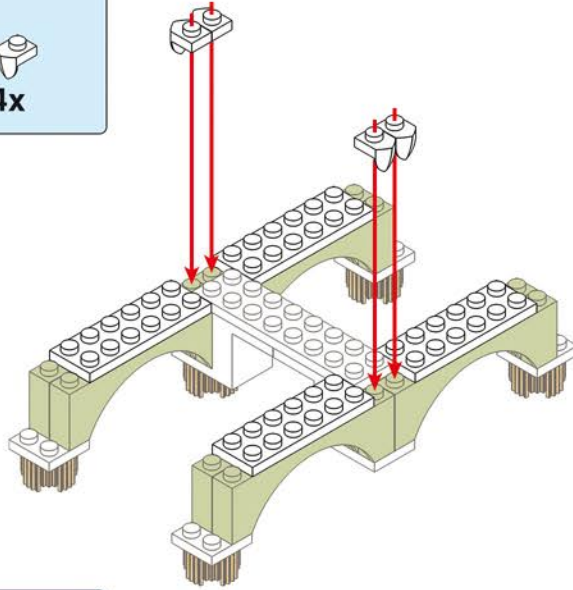

2-5

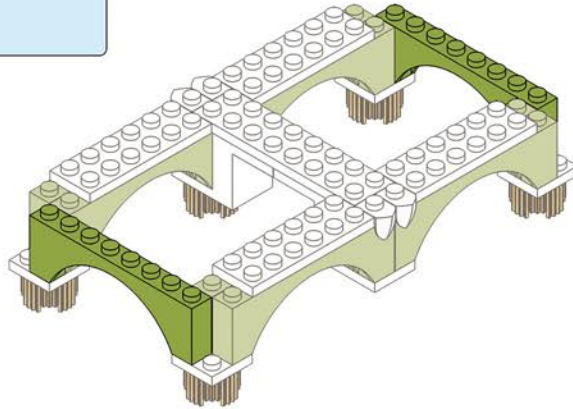

2-6

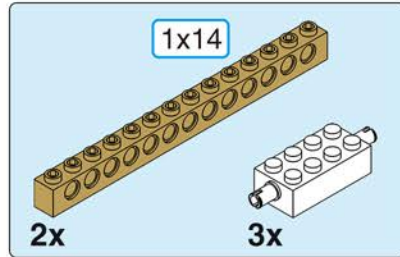
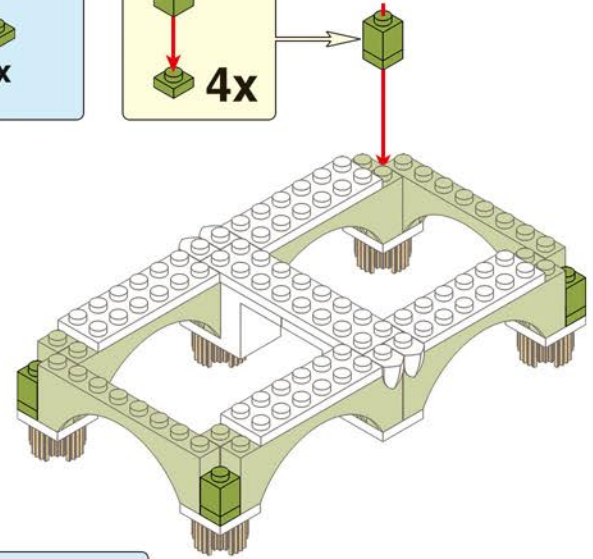
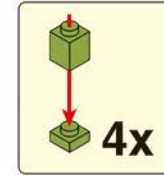

2-7

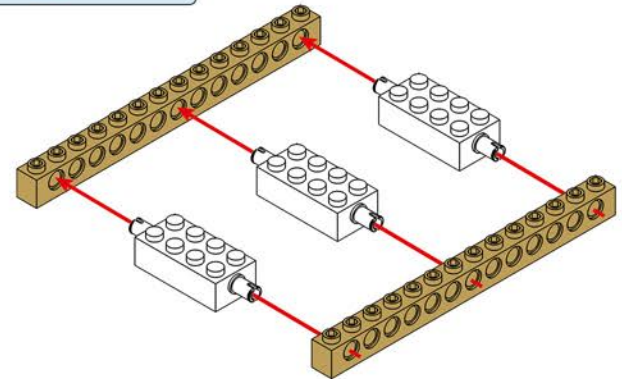



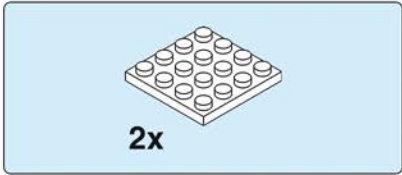

2-8

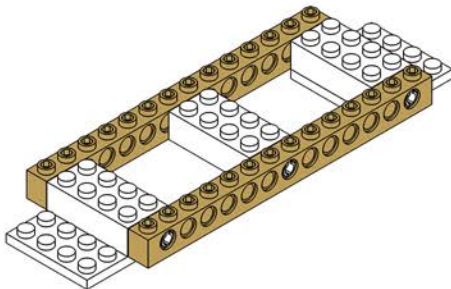
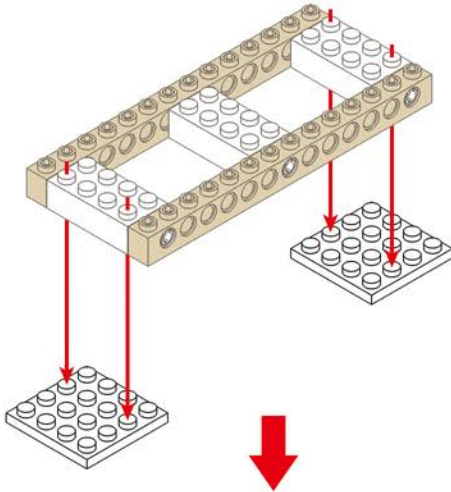

2-9

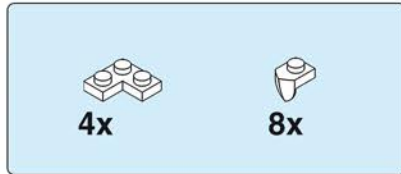
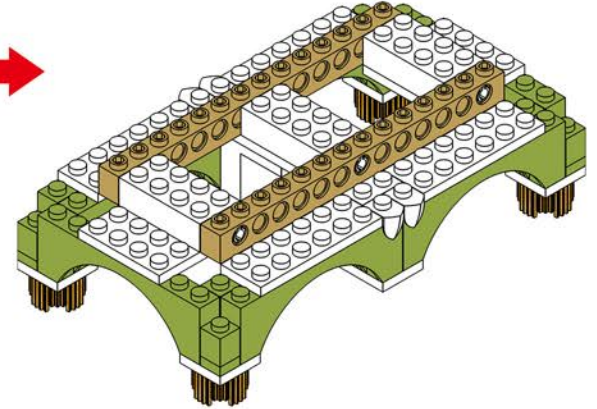
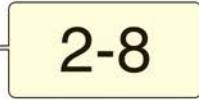
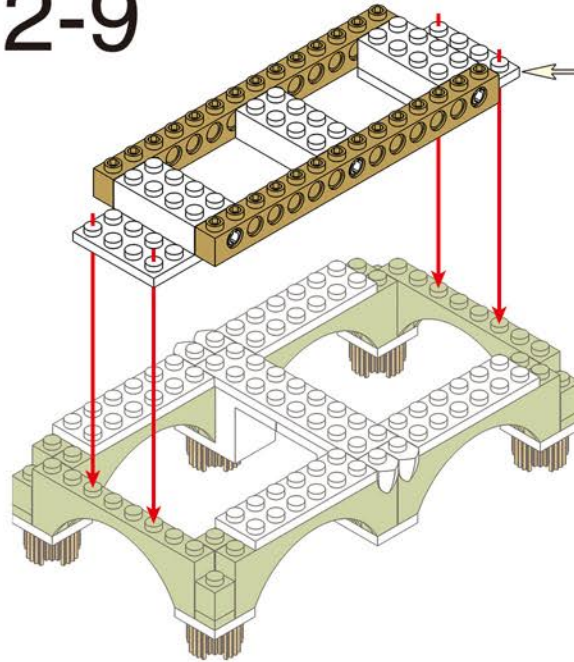

2-10

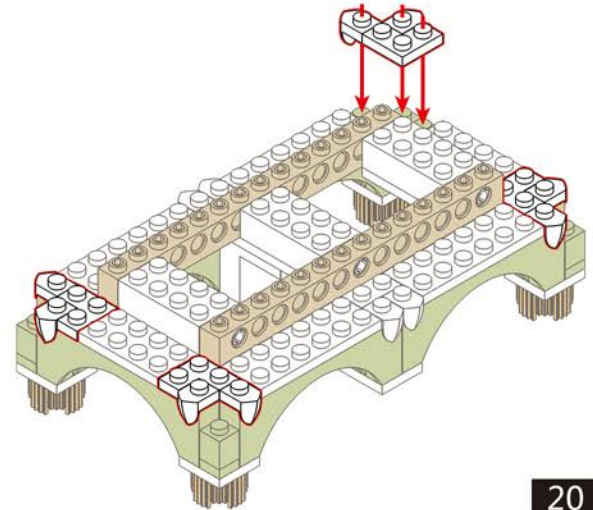

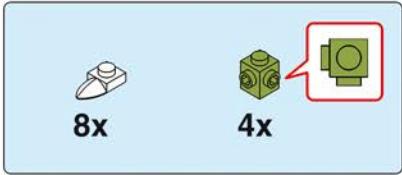

2-11

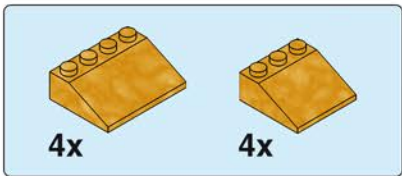
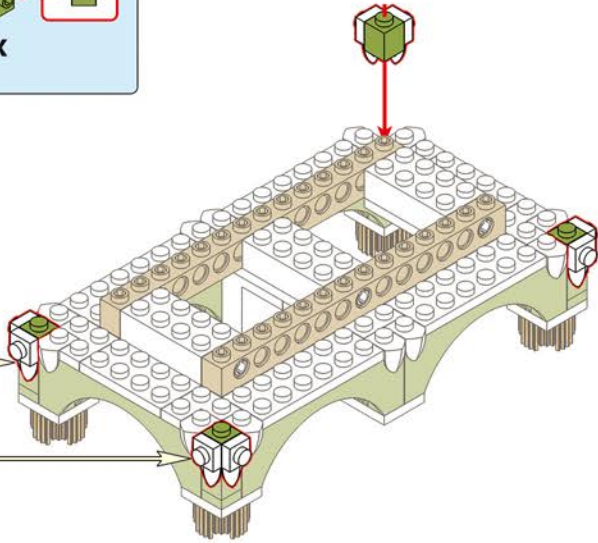
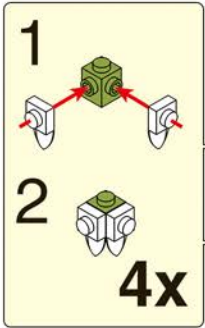

2-12

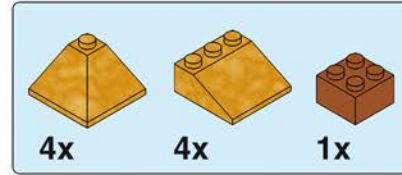
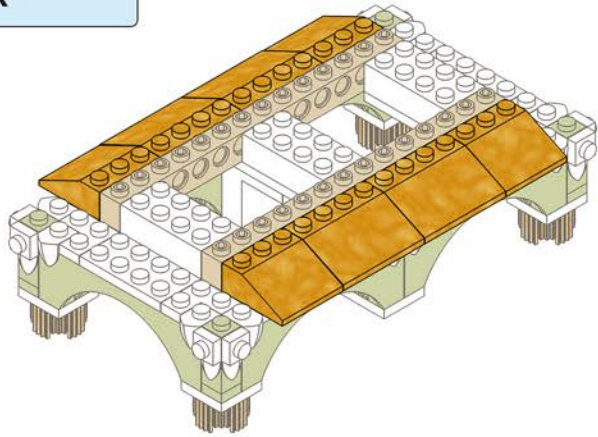

2-13

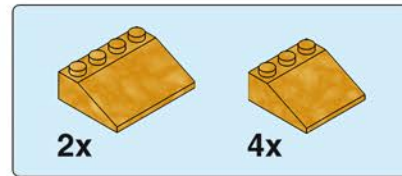
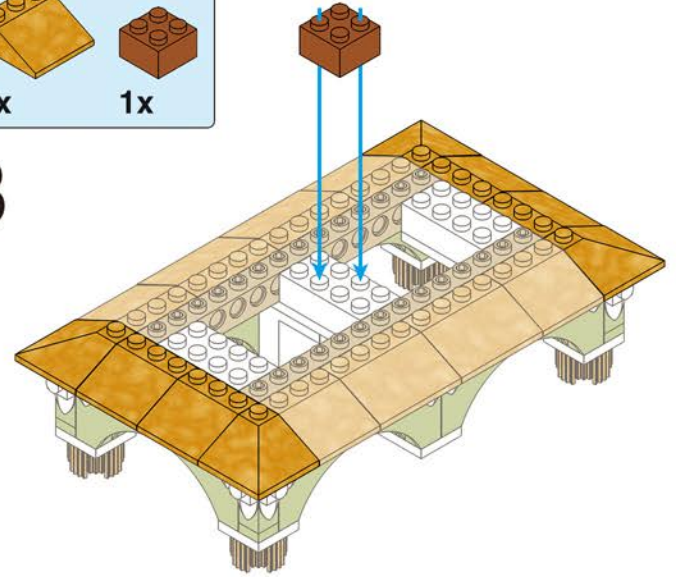

2-14

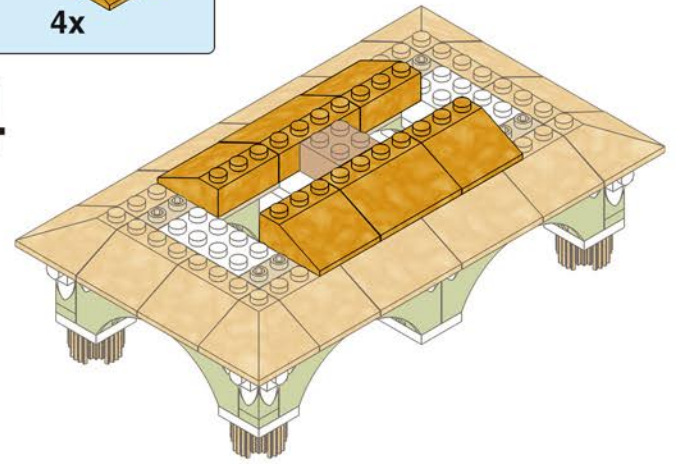



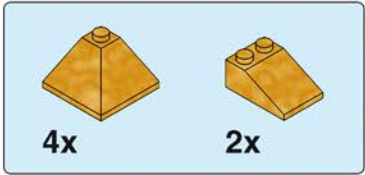

2-15

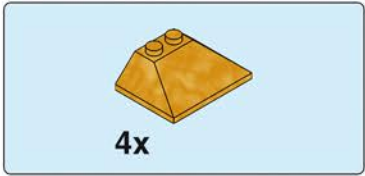
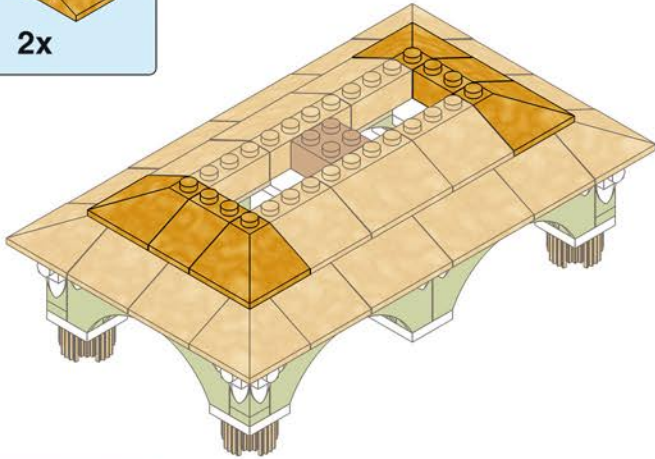

2-16

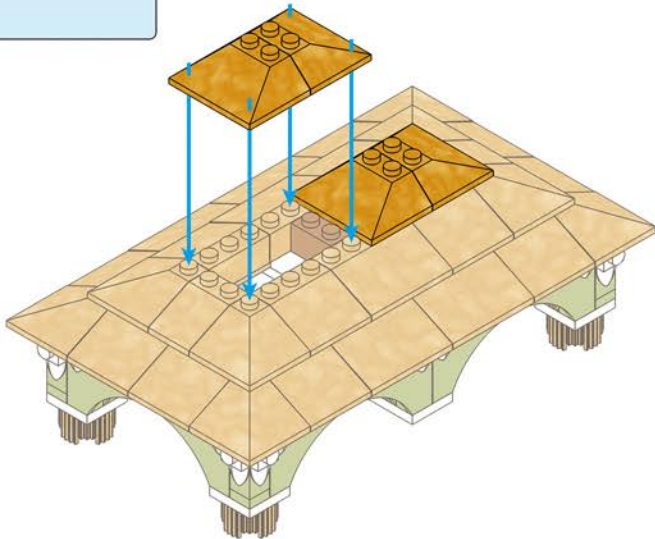

2-17

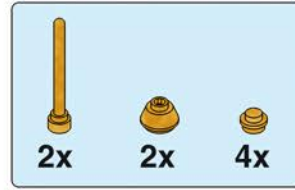
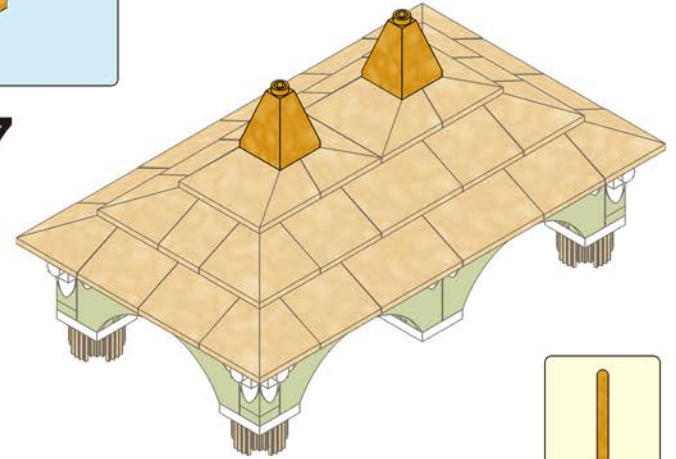

2-18

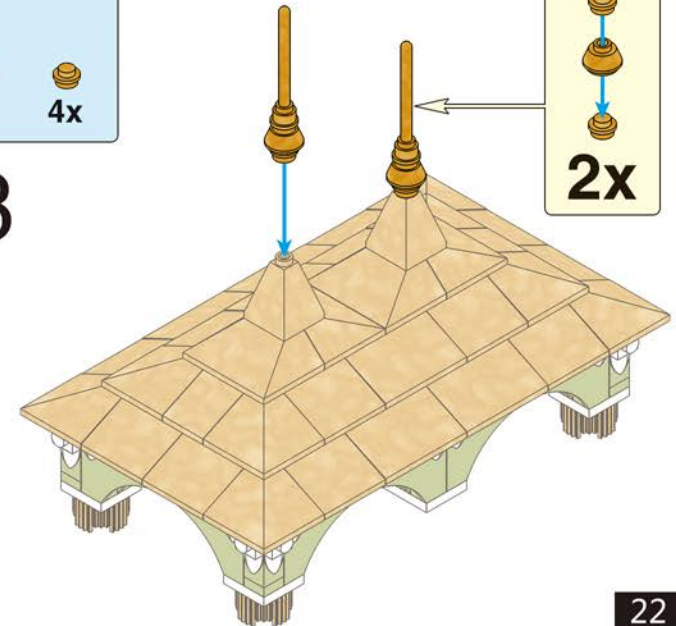





2-19

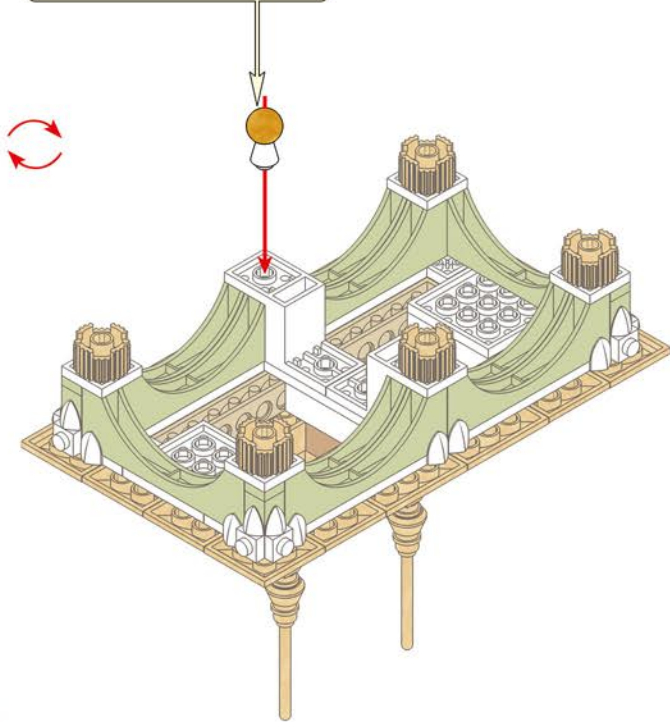
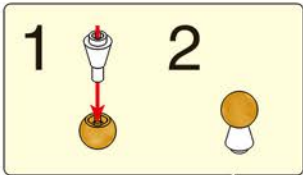

2-20

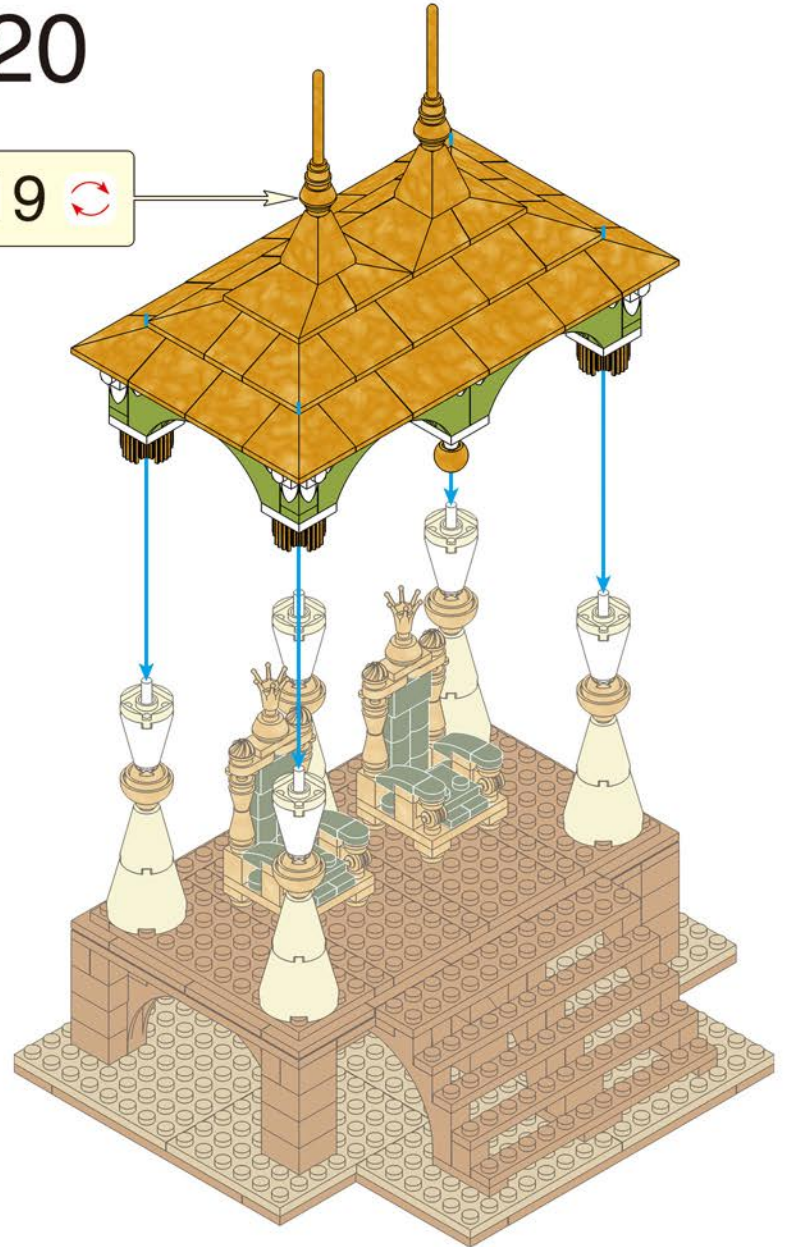

# 2-21

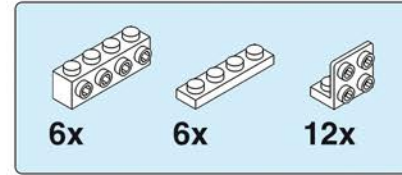

# 2-22

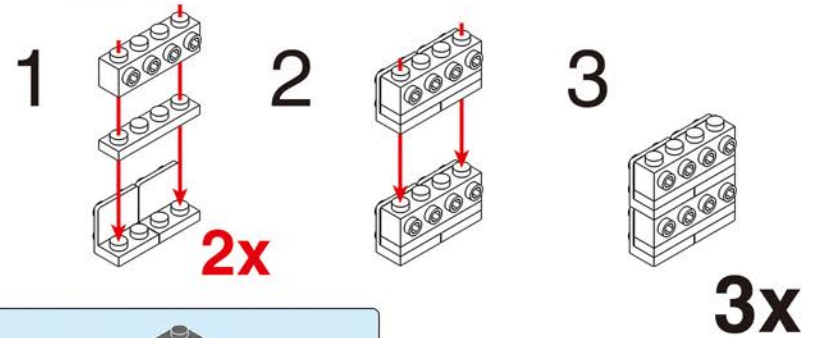

# 2-23

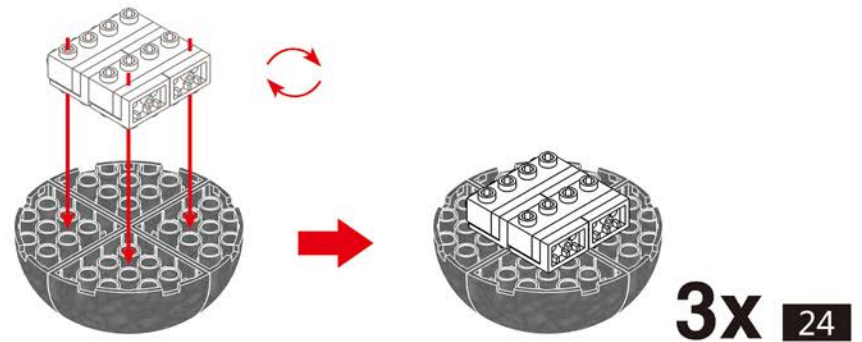



2-24

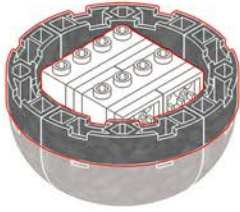

3x

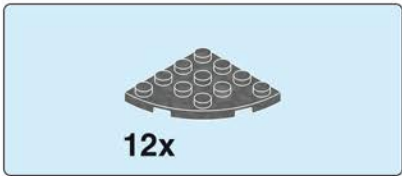

2-25

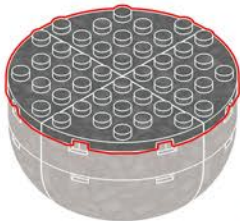

3x

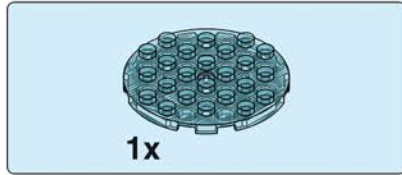

2-26

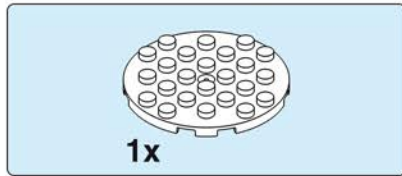
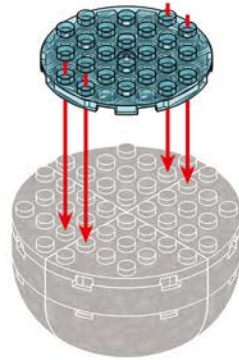

2-27

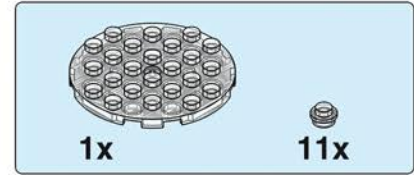
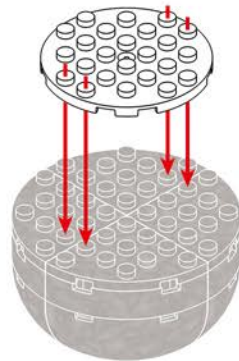

2-28

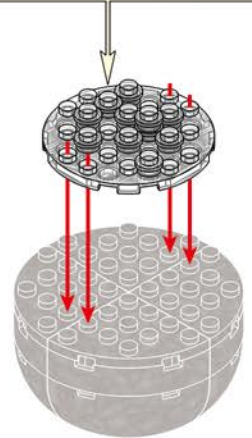
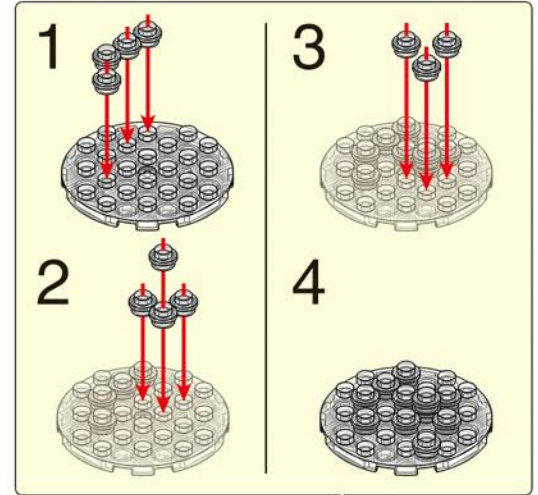



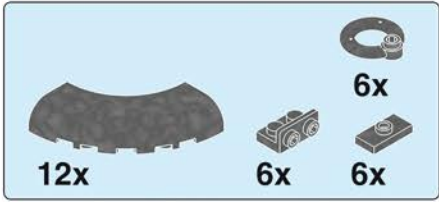

# 2-29

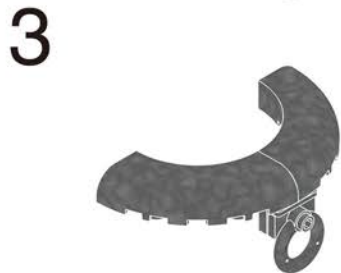
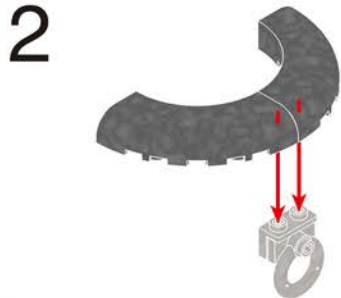
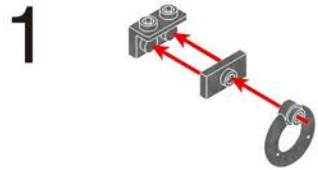

**6x**

# 2-30

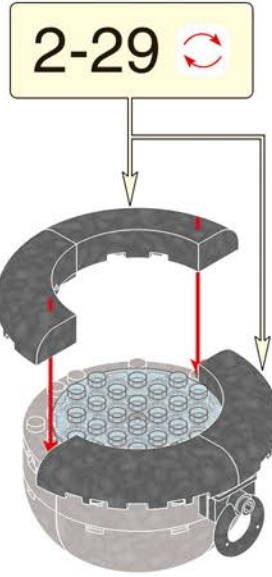



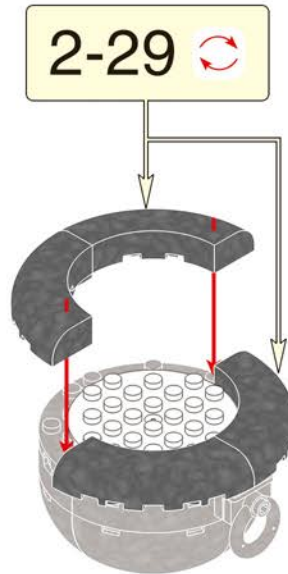

# 2-31

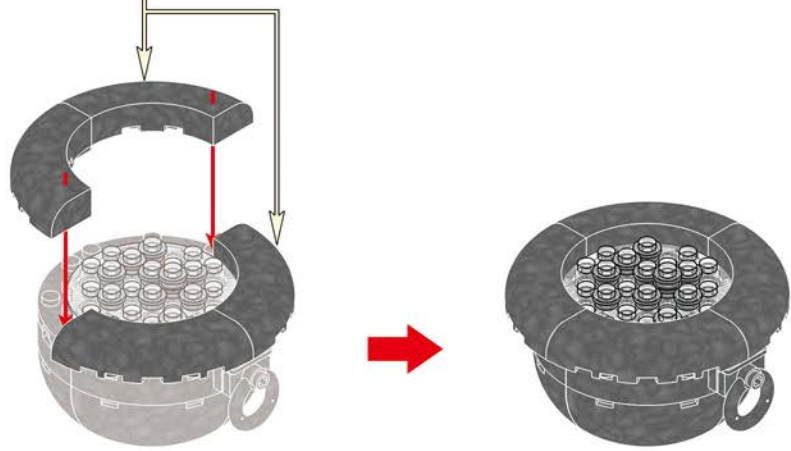

# 2-32

2-29 



 3x    3x    12x

# 2-33

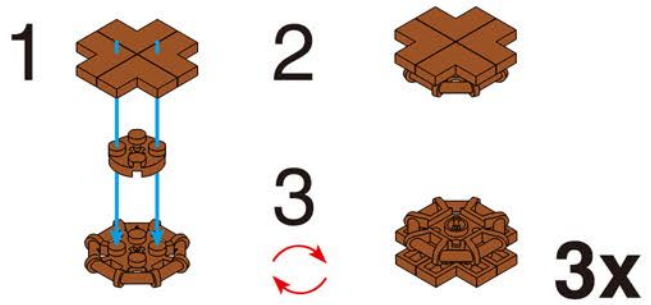

 16x    16x

# 2-34

 8x

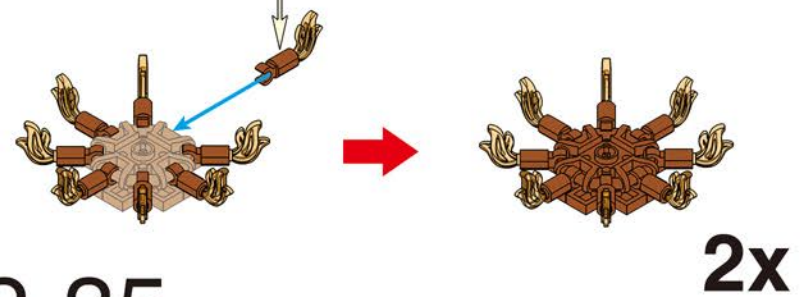

# 2-35

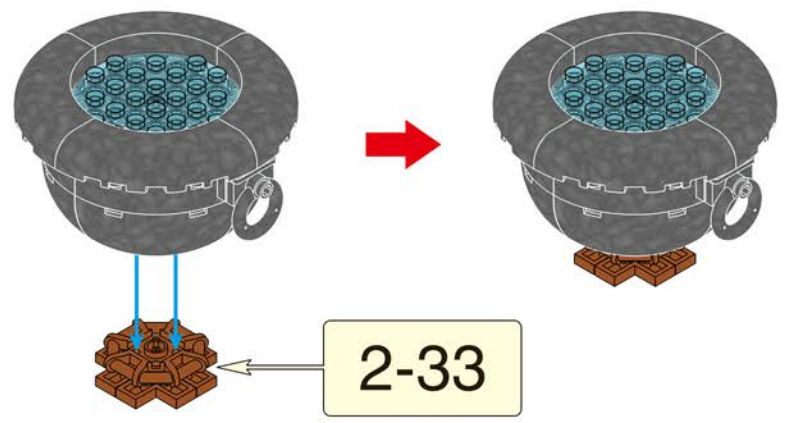

# 2-36

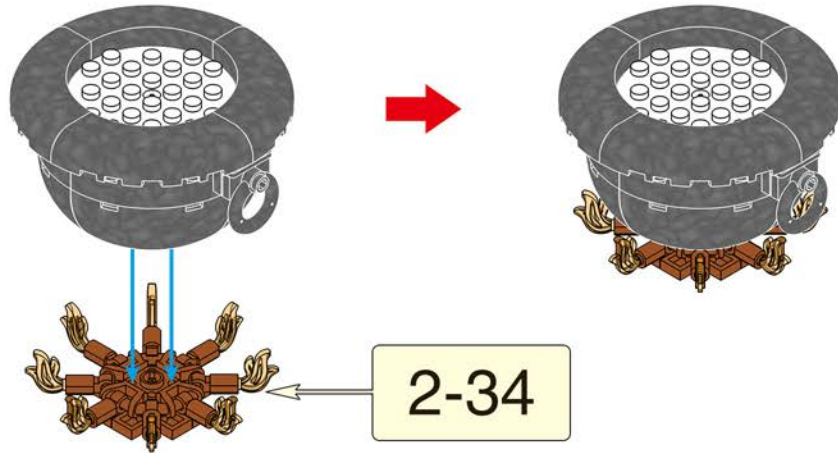

# 2-37

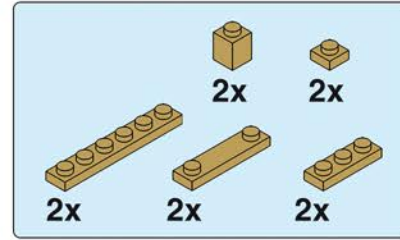
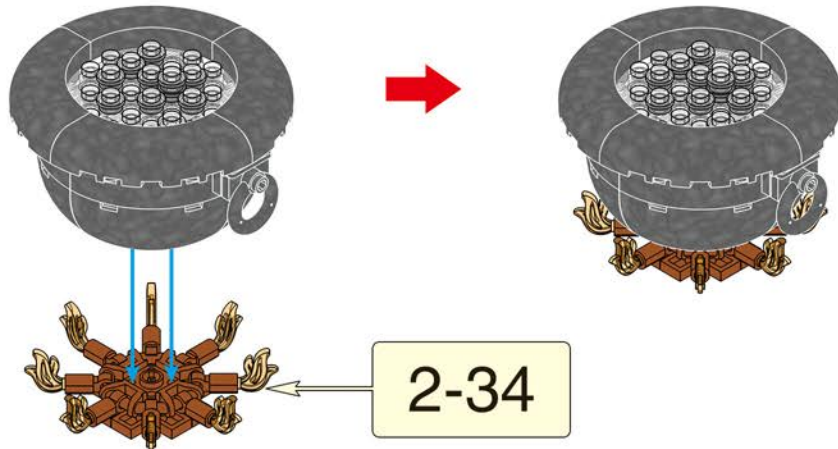

# 2-38

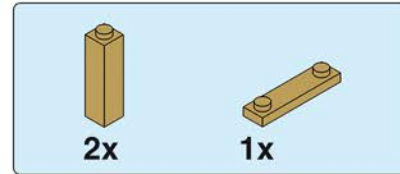
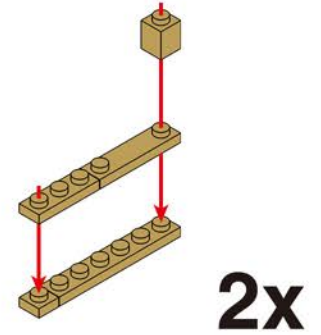

# 2-39

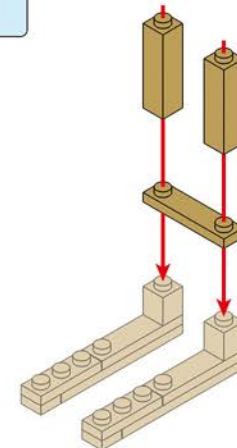



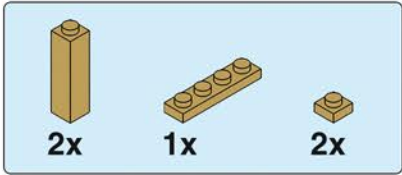

2-40

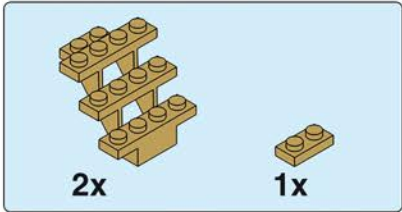
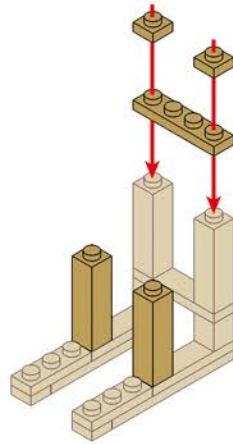

2-41

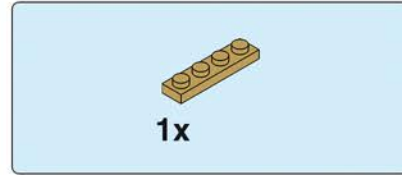
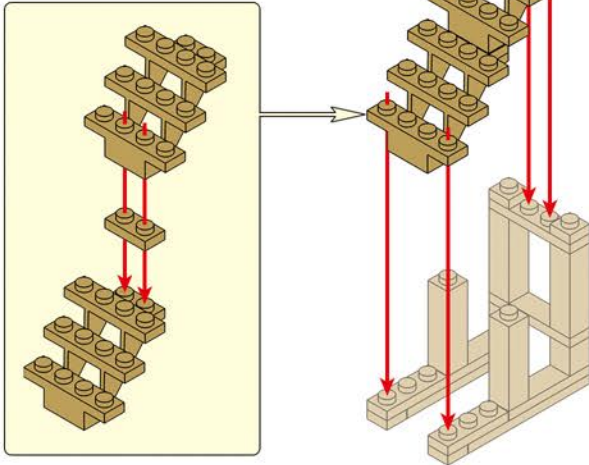

2-42

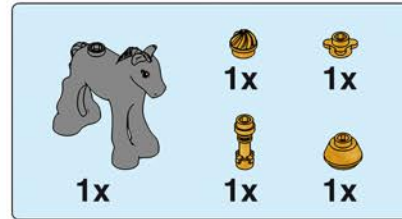
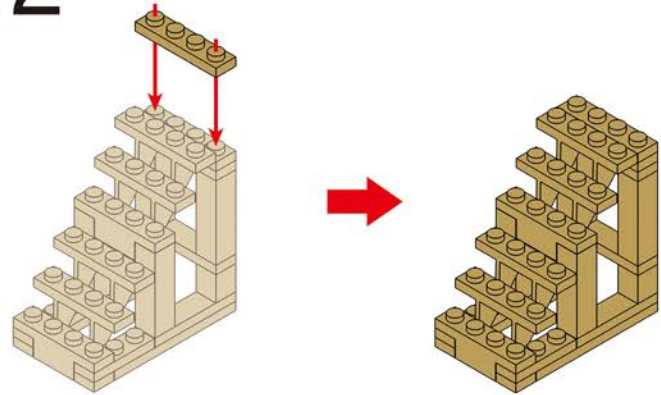

2-43

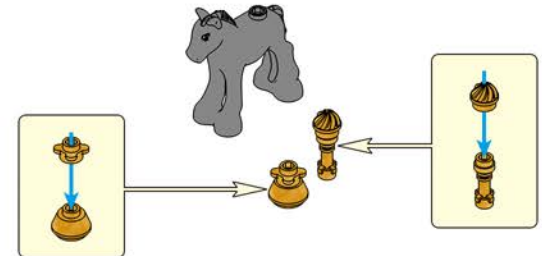

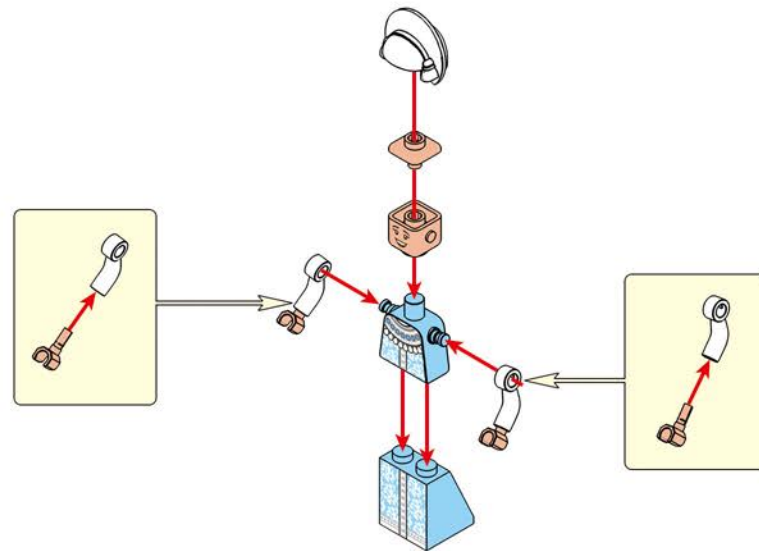
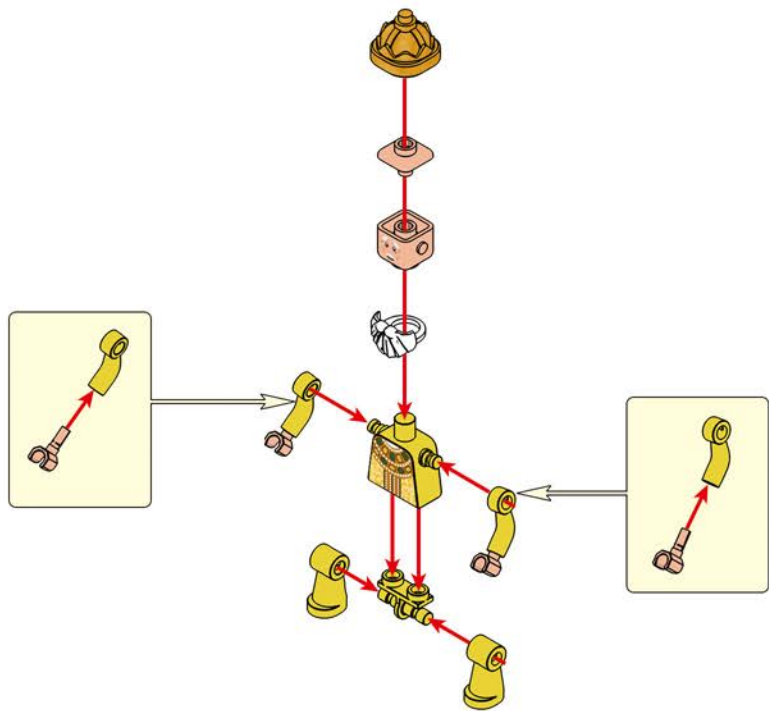

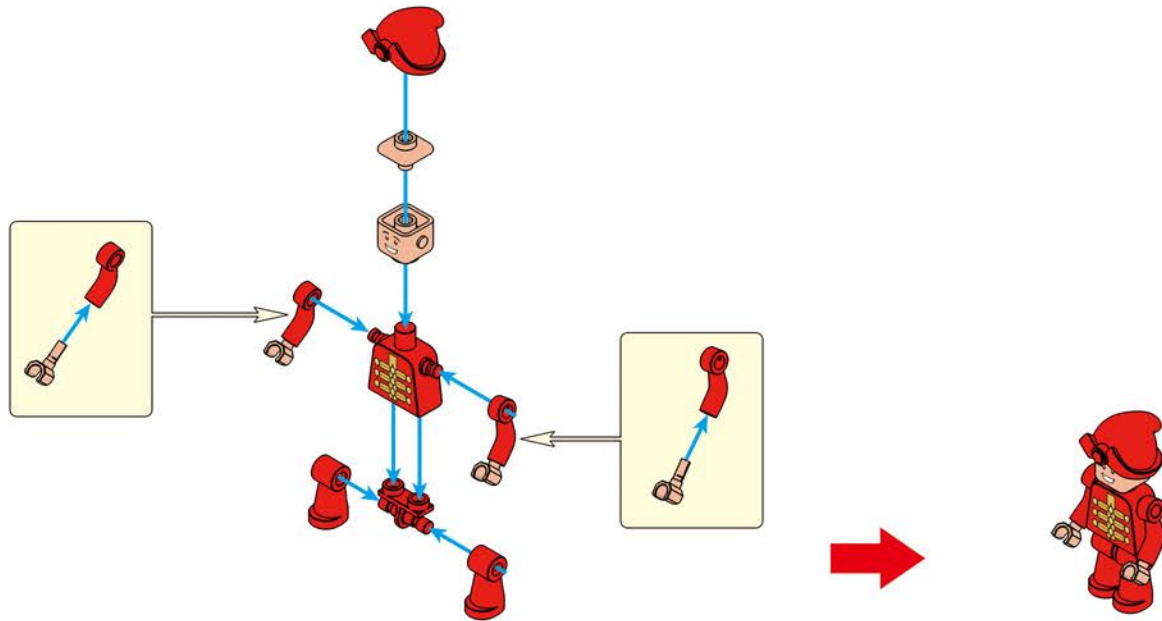





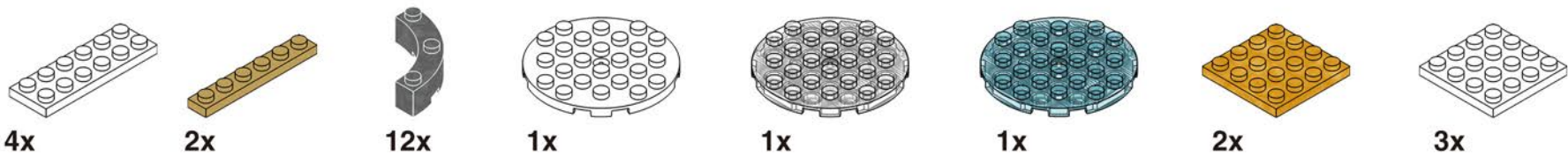
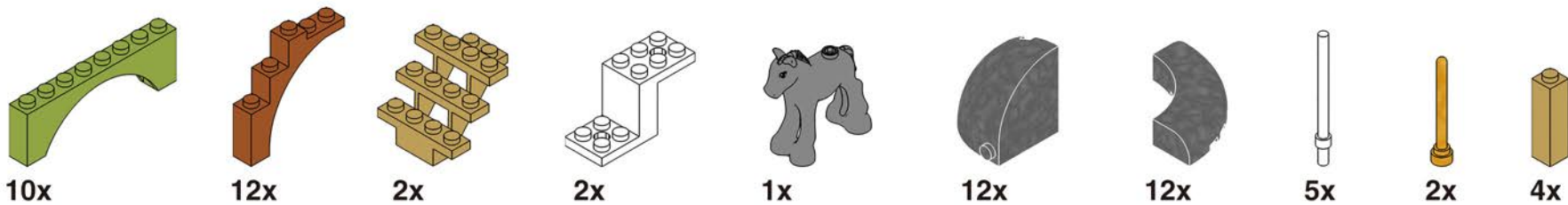
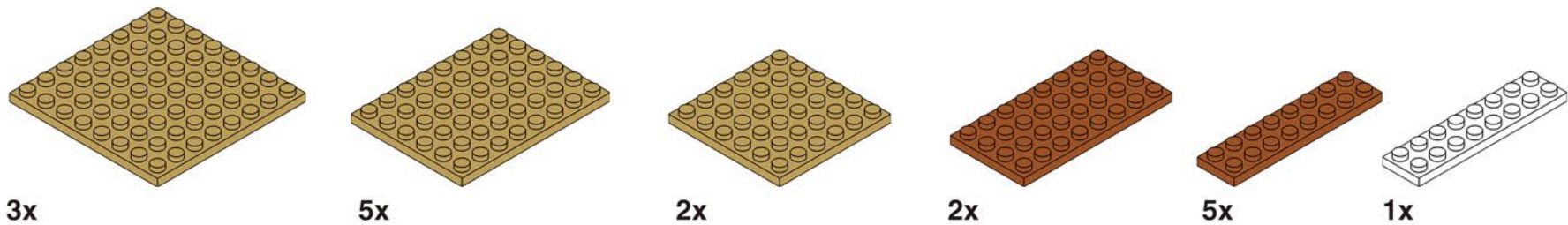
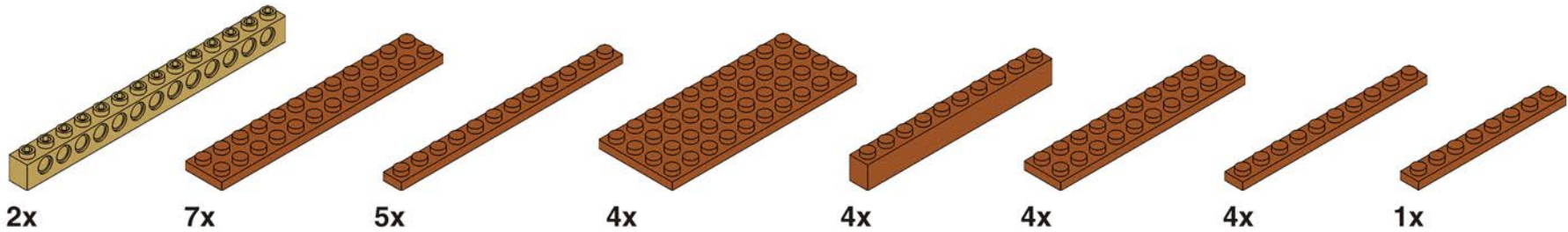

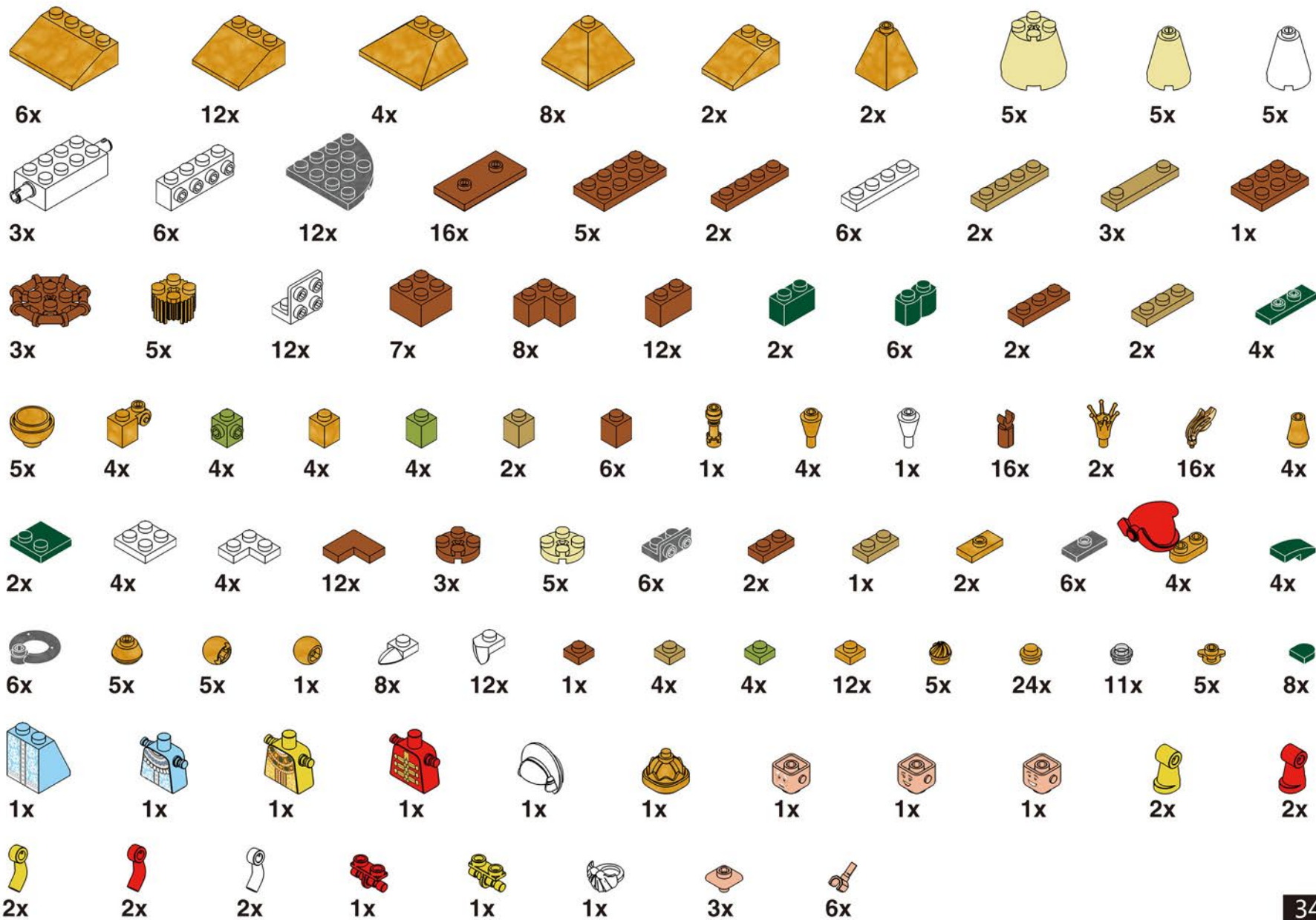



# ВСЕ КОНСТРУКТОРЫ СЕРИИ «СКАЗКИ»



БАБА-ЯГА



НОЧЬ ПЕРЕД РОЖДЕСТВОМ



МОРОЗКО



КОЩЕЙ БЕССМЕРТНЫЙ



КОНЁК-ГОРБУНОК



ПО ЩУЧЬЕМУ ВЕЛЕНЬЮ



РУСЛАН И ГОЛОВА БОГАТЫРЯ